



***HOST  
LINKS™  
Emulators  
Installation  
and  
Configuration  
on  
UNIX/Linux***

Microsoft, Windows, MS, MS-DOS are registered trademarks of Microsoft Corp.  
IBM and PC are registered trademarks of IBM Corp.  
UNIX is a registered trademark in the United States and other  
countries, licensed exclusively through X/Open Company, Ltd.

Any other product names are trademarks of their respective owners.

Version 6.3  
© Gallagher & Robertson as 1990-2005  
All Rights Reserved

**GALLAGHER & ROBERTSON AS**, Kongens gate 23, N- 0153 Oslo, Norway  
Tel: +47 23357800 • Fax: +47 23357801  
www: <http://www.gar.no/>  
e-mail: [support@gar.no](mailto:support@gar.no)

# Contents

---

<b>Host Links</b> .....	<b>1</b>
Architecture .....	1
Scope of the products .....	2
<b>Functional summary</b> .....	<b>3</b>
<b>Product architecture</b> .....	<b>5</b>
Architecture diagram .....	6
<b>Basic setup</b> .....	<b>7</b>
Installation .....	7
TERM variable .....	7
Environment .....	9
PATH .....	9
GAR_SYSDIR .....	9
GAR_MODE .....	9
<b>Host Links menus</b> .....	<b>11</b>
<b>Product startup</b> .....	<b>15</b>
Configuration files .....	15
Command syntax .....	16
Usage .....	16
Gdir.....	17
Tools.....	18
Gver.....	18
Gdump.....	18
<b>Host print in DSA networks</b> .....	<b>19</b>
Print to screen session .....	19
Pthru .....	19
Qsim .....	19
V78sim .....	20
Print on separate session.....	20
Gspool .....	20



<b>Context Manager .....</b>	<b>21</b>
Multiple sessions .....	21
General description.....	21
How to start Context.....	22
Moving between active contexts .....	22
Context configuration files .....	23
Example of context.cfg.....	25
<b>Profiles configuration .....</b>	<b>27</b>
General .....	27
File location .....	27
The DEFAULT profiles .....	28
The USER profiles .....	28
The SYSTEM profiles.....	28
File organization.....	29
Directive format .....	30
Screen update classes .....	31
List of available directives.....	32
Description of the available directives .....	33
BWMODE – force colour off.....	33
COLOUR – change default colour settings.....	33
COLOURMODE – force colour on .....	34
CONFIGDIR directory – directory for user configurations .....	35
CURSORSIM - software simulate cursor .....	35
DIREEDIT directive – configure editor for Gdir .....	35
DIRUSE pathname – user command file for Gdir .....	36
DOLLAR – permission to enter directory manager .....	36
EDIT - permission to run editor on screen image .....	36
EIGHTBIT - screen supports 8-bit characters.....	37
EXEC – permission to execute commands .....	37
EXTENDED - 8-bit characters over 7-bit path .....	37
HELPPDIR directory – help base directory .....	37
HOMEDIR directory – users home directory .....	38
KPAM - keypad application mode.....	38
KPNUM - keypad numeric mode.....	38
LANGKEY xx - configure 7-bit screen language .....	39
LANGUAGE ccc – configure dialogue language .....	39
LISTER directive – configure file list program .....	40
MACRO - permission to define keyboard macros .....	40
MENU – display program menus.....	40
MISCDIR directory – miscellaneous file directory.....	41
SERVERDIR directory – directory for servers .....	41



- SETUP - permission to run setup commands..... 41
- SEVENBIT - screen does not support 8-bit characters ..... 41
- SHELL – permit escape to shell..... 41
- SOUND – control alarm..... 42
- VIDEO handler - select video handler ..... 42
- VIPGLINK - VIP78 handler in Glink mode ..... 43
- VIPUNIX - VIP78 handler can assume UNIX mode..... 43

**Video handlers ..... 45**

- General information..... 45
- The VIP78 video handler..... 46
  - VIP78 handler using terminals ..... 46
  - VIP78 handler using Glink..... 46
- The TWS video handler..... 47
- The VT100 video handler..... 47
- The VT200 video handler..... 48
- The term video handler..... 51
- Terminfo files delivered ..... 53
  - Extra setup for the X11 xterm program..... 54
  - Extra setup for the CDE dtterm program ..... 55
  - Extra setup for the FTP Software TN.EXE program..... 55

**Interactive commands ..... 57**

**Character sets..... 59**

- Limitations of the 7-bit set ..... 59
- National substitutions ..... 59
- The 8-bit standard..... 61
- Host Links character set ..... 62



- Using the 8-bit set..... 63**
- 8-bit terminals (EIGHTBIT)..... 63
- 7-bit terminals with mapping (EXTENDED)..... 63
  - Glink ..... 63
  - The DKU7102 (TWS21xx)..... 64
- 7-bit terminals (LANGKEY)..... 64
  - Display of 8-bit characters ..... 64
  - Entering 8-bit characters ..... 65
- 8-bit terminals viewing 7-bit characters ..... 65
  - Default national view ..... 65
  - Toggle to national view (CTRL/F)..... 66
  - Data entry while viewing 7-bit..... 66
  
- Appendix: Host Links Manuals..... 67**
  
- Appendix: The text library ..... 69**
  - gcptexts - Maintain program texts..... 69
  
- Appendix: Error Codes..... 71**
- OSI/DSA error codes..... 71
- Windows Sockets error Codes..... 83

# Host Links

## Architecture

The G&R Host Links product set is available on all major UNIX, Linux and Windows server platforms. This document is for use by those installing and configuring the UNIX/Linux terminal emulators in the product range.

VTnnn, xterm, ... terminal environment

Qsim  
V78sim  
G3270

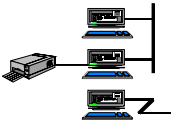

Gspool  
GUFT  
GIAPI  
Gproxy

LAN Workgroup, PCs and Macs with *Glink*

Ggate

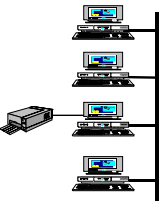

Gweb  
Gspool  
GUFT  
GIAPI  
LDSA  
Gproxy

VIP7800 terminal environment

Pthru

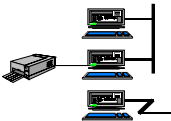

Gspool  
GUFT  
GIAPI  
Gproxy

Host Links platforms

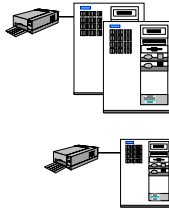

Powerful, multi-CPU  
UNIX or Windows NT



Windows NT or  
UNIX on PC

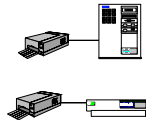

Bull/IBM  
Mainframes



# Scope of the products

The purpose of the Host Links product set is to make Bull and IBM mainframe applications accessible from the Open Systems world. It provides terminal, printer, file transfer and application-to-application connections from Windows and UNIX/Linux servers. This manual concerns the configuration of Host Links emulators on UNIX/Linux platforms. Installation of basic Host Links, communications and the products other than emulators is described in the Host Links Installation and Configuration manual. This manual concerns only the emulations.

Qsim allows UNIX/Linux terminals to emulate the VIP7700, VIP7760, DKU7107 and DKU7211. All the emulations are included in one product for access to applications running on GCOS8/7/6 systems. VIP7700 and VIP7760 are included for access to the older applications, and DKU is for access to newer applications using the presentation that is standard within Bull S.A.

V78sim allows UNIX/Linux terminals to emulate the VIP7800 (HDS) for access to applications running on the same range of GCOS systems using the presentation that is now standard within Bull-HN. V78sim emulates character, text and forms mode.

G3270 allows UNIX/Linux terminals to emulate the IBM3270 for accessing IBM mainframes through the SNA gateway on the Bull front-end, or using Telnet/3270 to connect over TCP/IP. G3270 can also be used to access applications on Bull GCOS systems that use 3270 presentation.

G5250 allows UNIX/Linux terminals to emulate the IBM5250 using Telnet/5250 to connect over TCP/IP to IBM AS/400 servers.

Pthru is a gateway to the Bull primary network for either standard VIP7800 (HDS) terminals or PCs and Macintoshes running a VIP7800 emulator.

With all of the above products we deliver Basic and Gline. Basic comprises a set of utilities and a menu system that is used by all the products, and which may also be used freestanding. Gline is a set of 'line handlers', which all the products use to make mainframe connections.



# ***Functional summary***

---

The G&R Host Links products transform any Windows platform into a native DSA or DSA/ISO Workstation (DIWS) node in the Bull primary network, or into a 3270 cluster within SNA. Communication between the Windows system and the Bull systems is generally done using the Bull DSA session protocol. Communications with IBM systems is by TN3270/TN5250.

The DSA connections can be made in the traditional way using OSI-transport, which is a requirement when connecting via old-style Datanets. The Bull systems can be accessed over an X.25 WAN or Ethernet LAN through a Datanet or MainWay front-end. Alternatively access can be direct to GCOS6 using a LAN adapter or direct to GCOS7 using ISL. Access can be by an FDDI LAN direct to GCOS7 using FCP7 or direct to GCOS8 using FCP8.

The DSA connections can also be made over a TCP/IP network, using the Internet standard RFC1006 transport protocol to replace OSI-transport. MainWay front-ends with an ONP (Open Network Processor) have RFC1006 support in the standard product, allowing DSA sessions over TCP/IP into the MainWay. RFC1006 can also be installed in the FCP7 and FCP8 cards to support DSA connections direct to the hosts without passing through the front-end. The GNSP on newer GCOS8 systems accepts DSA/RFC1006 connections, as does the newer GCOS7 Diane systems. G&R Host Links systems are qualified with both.

The Ggate product may be used to off-load the DSA session protocol into gateways. By running Ggate on the system(s) with the host connections all other PCs, Macintoshes, Windows and UNIX machines in your network need only the very small and efficient Ggate protocol layer to connect over TCP/IP to a Ggate gateway with full primary network functionality. Ggate can make the host connection using OSI-transport or RFC1006. If you must use OSI-transport for the host connection, using Ggate will limit the need for OSI-stacks to the Ggate platforms.

IBM systems can also be accessed using Telnet 3270 (TN3270 or TN3270E) to connect to any TN3270⇔SNA gateway or front-end. The MainWay gateway, the TN3270 server on the Bull DPX/20 UNIX systems, the IBM TN3270 front-end and the TN3270 server for Windows are all qualified.

Bull systems can also be accessed using Telnet VIP (TNVIP). The TNVIP servers in the MainWay and in the Bull DPX/20 are both qualified. However, RFC1006 is supported in the MainWay front-ends with an ONP (Open Network Processor), and if used when communicating with G&R products it will increase throughput as compared to using TNVIP. It will also give a real, fully functional DSA or DIWS session over the TCP/IP network, as compared to the limited terminal session offered by TNVIP.

# Product architecture

---

The UNIX/Linux versions of the G&R products are built in a modular way, and designed to take advantage of the multitasking capability of the UNIX/Linux platform. Thus a single instance of a product will in general consist of three quite separate processes, communicating with each other using pipes and shared memory. In general there will be:

- A video handler; which accepts user key input and transforms it into the internal standard format. It also maps all updates of the internal screen image into the control sequences required to update the specific screen being used.
- A product; for example an emulator which accepts key input in the standard format and updates the internal screen image according to the presentation being emulated. An emulator will also send and receive data to the mainframe system using the standard interface that applies to all communications protocols.
- A line handler; which maps the standard format for communications into the specific line protocol being used.

This structure has proven itself extremely efficient and very robust. We are able to develop a video handler for a new screen type, and we know that once it works with one G&R product it will work for all. We are able to develop a new line handler and know that once it works with one product it will work with all. We are able to develop a new product using a given screen and communications protocol, and know that the product will work with all screen types we support, and with all the communications protocols we support.

Ggate, Gspool and GUFT server differ slightly from the above model, as they don't need a video handler, only a line handler.

Some of the programs in the Basic product, like Gdir and Glist, also differ slightly as they don't need a line handler, only a video handler.

# Architecture diagram

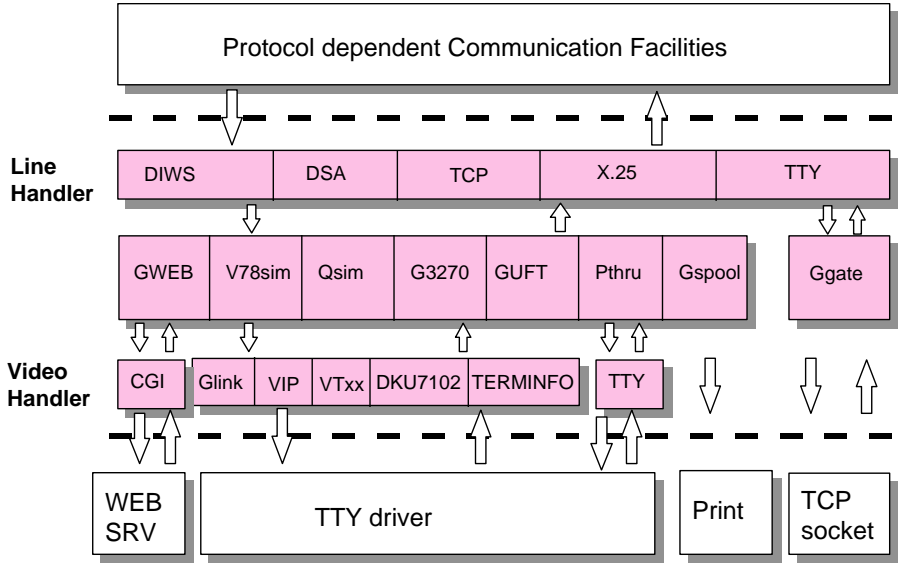

# Basic setup

---

## Installation

Please refer to the manual *Installation & Configuration of Host Links Servers* for the procedure used to do the basic installation and setup of the Host Links system, including communication stack. This manual deals with the options available for changing the profile of a UNIX/Linux terminal user when accessing the Host Links products having a screen interface. These include the emulators: Qsim, V78sim, Pthru, G3270, G5250 and some administrative tools.

## TERM variable

Users of the Host Links terminal handling products such as the Qsim, G3270, and V78sim emulator family, and users of the menu system, file navigator and utilities included in the basic product set must select the required video handler. The video handler must match the terminal type they are using. The most convenient way of doing this is to set the TERM variable. TERM selects the Terminfo file used by UNIX/Linux applications to control specific terminals, so Host Links generally tests only the first few characters of the TERM, so that various Terminfo files may be used. The choices are:

Vt1xxxx	any TERM variable starting with vt1 will select the vt100 video module. Used for VT100 terminals and clones.
Vt2xxxx	any TERM variable starting with vt2, vt3 or vt4 will select the VT200 video handler. Used for VT200, VT300, VT400 terminals and clones.
tws21x	any TERM variable starting with tws21 (or dku7) will select the handler for the Bull DKU7102 terminal or clones.
vipxxxx	any TERM variable starting with vip will select the handler for the Bull VIP7801 (up to HDS 7) terminal or clones.
glinkxxx	any TERM variable starting with glink will select the VIP

	handler and enable the Glink extensions on entry to Host Links. Glink reverts to VTnnn on exit (see <code>glinkvt</code> below).
<code>glinkvip</code>	selects the VIP handler with Glink extensions, and leaves it in VIP78 mode when executing other UNIX/Linux products. This is the recommended way of running UNIX/Linux with Glink.

Any other `TERM` variable will select the generic video handler that controls stranger terminals using the `Terminfo` file. The UNIX/Linux administrator can set the `TERM` variable in the default `/etc/profile` or user-specific `.profile` (or equivalent for the UNIX/Linux shell being used).

```
TERM=vt220;
export TERM;
```

or

```
TERM=glinkvt;
export TERM;
```

If not set there, it can be picked up from the terminal at connect time if the Telnet terminal type response is configurable.

Glink users can choose between using extended VIP78 mode always (as recommended), or only when running Host Links. We deliver improved `Terminfo` files for Glink users: `glinkvip` for users who start in VIP78 mode and remain in it, and `glinkvt` for users who start in VTnnn mode and switch in/out of VIP78 mode on entry/exit to/from Host Links. Note that we also deliver extra set-up programs for users of X.11 terminals, users of the `dtterm` product under the Common Desktop Environment and users of FTP software's `TN.EXE` terminal emulator on the PC. All are described in the same section entitled *Video handlers*, and the sub-section *Terminfo files delivered*.

# ***Environment***

Some configuration can only be done using UNIX/Linux environment variables. It isn't possible to configure these parts using the profiles or configuration files, as they actually specify where these files are and how they should be interpreted.

## ***PATH***

It is recommended that you add the location of the Host Links program files to your PATH. The location is `/usr/gar/bin` by default. The PATH update will normally be done for all users in the system-wide `/etc/profile` shell script, but may be set individually. Should you decide not to change the PATH then it is also possible to run any Host Links program by specifying the complete path name.

## ***GAR\_SYSDIR***

This is not normally set. If you did not install Host Links in the default directory, `/usr/gar`, it has to be set to the name of the directory where you did install it.

## ***GAR\_MODE***

This is not normally set. In some circumstances it may however be useful to specify the mode part of the user ID for a particular user in particular circumstances. It can be used in selecting special sections from Host Links profiles and configuration files. As UNIX/Linux doesn't have log-on modes they can instead set using this environment variable.





# Host Links menus

The Host Links utilities in the Basic package delivered with all other Host Links packages include a menu display and navigation system, *Gmenu*.

If you enter the command `gmenu` at the command line you will see the following display (here using the G&R/Glink terminal emulator as a UNIX/Linux terminal):

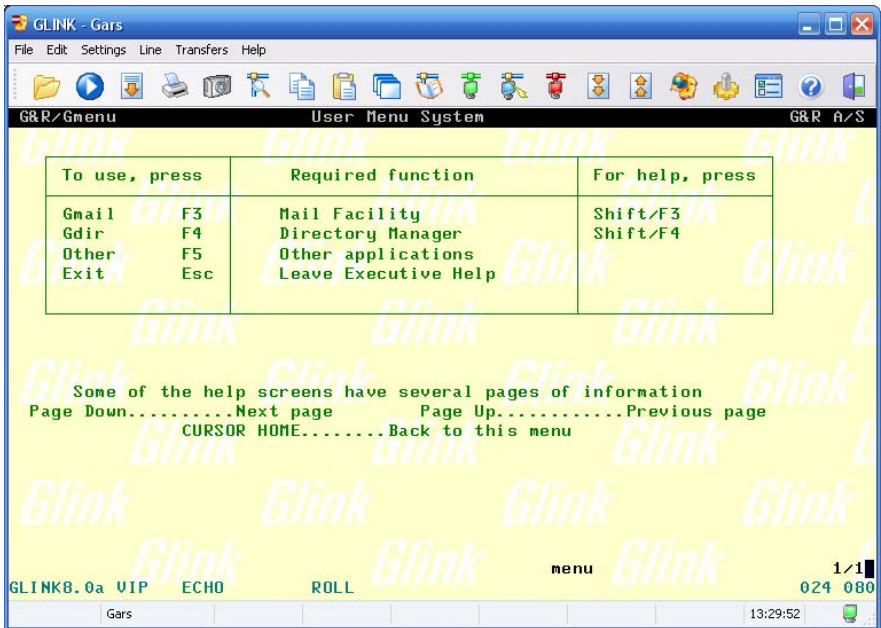

This facility is used for navigating in user menus and executing commands. The G&R applications such as *Qsim* use it for navigating in help menus. In both cases it allows unlimited user extension of the help menu network, and activation of applications from the menus. In the menu above only the F4 key to start Gdir will work unless you have licensed Gmail. Press Esc (twice) to leave the menu.

The help facility may be added to your own applications merely by providing for execution of a `gmenu myhelpdir` command from the application. In this way you may add all the functionality of the G&R/help system to your own programs, and at the same time save a lot of development resources that would otherwise be used in adding a menu capability inside the application.

The default menu presented when you execute the command line can be found in `/usr/gar/help/menu` (a help directory must contain at least one menu file with name `menu`) and can be modified using your favorite text editor. However if you press the double quote (“) on your keyboard while viewing the menu; this default menu key starts *Gedit* and loads the menu ready for editing. *Gedit* has a line graphic edit/display of the Host Links character set, and you would see the following, except that the standard menu file loaded into *Gedit* would be: `/usr/gar/help/menu`:

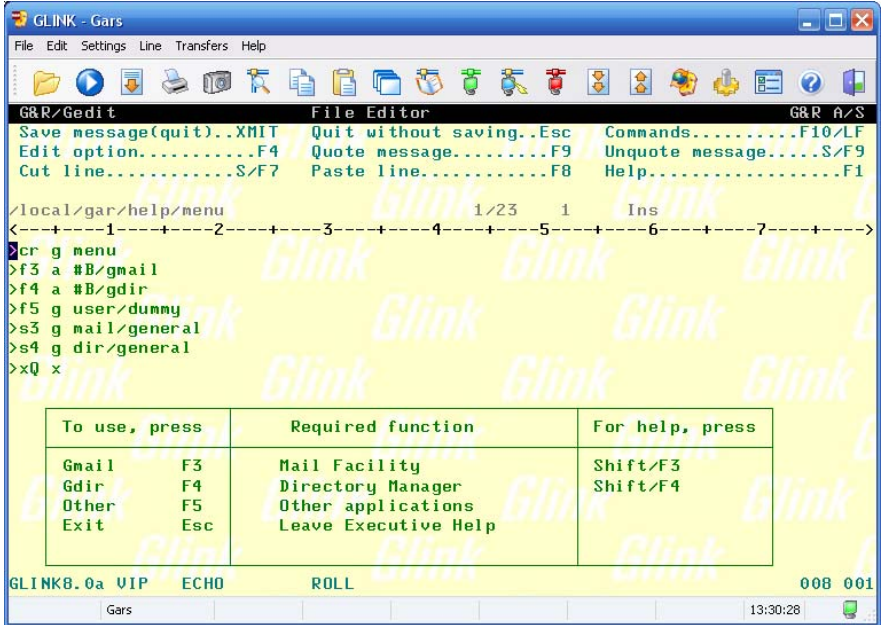

The line graphics were entered into the file using the line graphic capability of *Gedit* (LF G to start, LF SPACE to stop). The menu is activated by the command lines (>) that precede the display text.

directive	action when:	command	what happens
>cr	key CR is pressed	a #B/qdir	activate G&R video interface product

>f3	key F3 is pressed	e #B/pthru	execute other G&R or external product
>s4	key shift F4	q	go to menu. relative to help directory
>xQ	key O is pressed	x	exit menu system

To add *Qsim* and *Pthru* to this menu add the two command lines for F1 and F2 as below, and use the line graphic capability of *Gedit* (LF G to start, LF SPACE to stop) to modify the drawing, as follows:

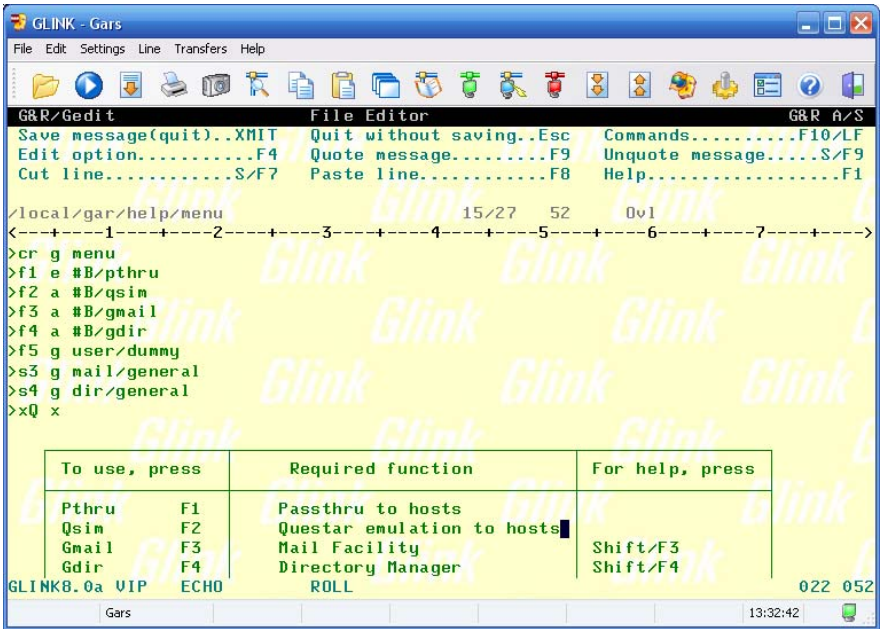

On exiting from *Gedit* with update file (LF W) you will be returned to the menu, but now showing the two new commands available.

- F1 the **e** executes *Pthru* with no command line options
- F2 the **a** activates *Qsim* with no command line options

If you exit without updating (LF Q) then the menu is untouched. Use the help (LF H) in *Gedit* for details on its capabilities.

Please refer to the *G&R/Gmail reference* manual for details of *Gmenu*.



# Product startup

---

## Configuration files

Configuration files from earlier releases are not overwritten, the sample files are left in the `/usr/gar/install` directory. After running the installation program for the first time on a system sample configuration files for the various products can be found in:

```
/usr/gar/config/default
```

You will find the files:

```
gweb.cfg  
gwebs.def  
cpic.cfg  
qsim.cfg  
pthru.cfg  
v78sim.cfg  
g3270.cfg  
guft.cfg  
context.cfg
```

Modify these files to suit your configuration. The user guides for the products describe all available parameters. Users need read permission for the configuration files they use and the files might include passwords in the parameters. For security you may create individual configuration files for each user in the directories:

```
/usr/gar/config/$LOGNAME
```

Each of the configuration files created in these directories will only be read for the given user, and can be protected from all others using standard access control. The default configuration directory will **NOT** be used for users who have a private directory. *Gweb* and *CPI-C* parameters **MUST** be supplied in the default directory, they do not look for a user directory.

## Command syntax

Products may be started at the UNIX/Linux prompt, from Gmenu or from shell scripts etc. with commands in the form:

```
product [-xx yyyyyy ]
```

where `-xx yyyyyy` is one or more legal parameters.

e.g. `qsim -cl 7q -xl ge -li dsa -dn en40 -da tss`

Parameters are by default for the product. The `-li` option signals the name of the line handler and that the following parameters are for the line handler instead of the product. It is also possible to switch back and forth between product parameters and line handler parameters using the `-user` and `-host` options.

e.g. `qsim -li dsa -dn en40 -user -xl ge -host -da tss`

Switching back and forth in a command line is not particularly useful, but when using a configuration file it is extremely important to remember to switch between product and line parameters as they are picked up from different sections of the file.

## Usage

Please refer to the individual product manuals.

# Gdir

This is a directory navigation and file edit/display/execute tool. The editor and display programs used are configurable so you can replace them with your favorites. The keyboard is configurable so that you can add shortcut keys that make several of your favorites available for use on the selected file. Gdir is supplied as a character based utility `gdir` (UNIX/Linux binary) or `gdir.exe` (PC console application).

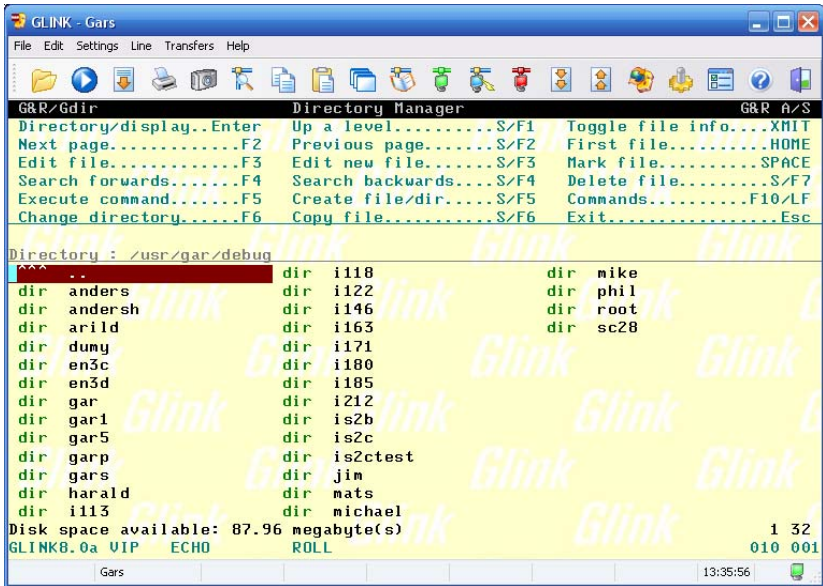

You might find this very useful when navigating in the Unix/Linux file system to look for Host Links configuration or trace files. In the Windows environment it offers somewhat different functionality than MS Explorer.

## Tools

### Gver

This is a utility program that lists the version number of the G&R Host Links release programs that you are using. Gdir is supplied as a character based utility `gver` (UNIX/Linux binary) or `gver.exe` (PC console application). It can be used to list only the release number, or to list details of all G&R software installed:

```
jim@gars ~ $ gver -r
6.3.0/spaso
```

```
jim@gars ~ $ gver
```

```
3270web 2398792 gweb/cpicweb 6.3.0/spaso Apr 6 2006 13:49:30
5250web 2492104 gweb/cpicweb 6.3.0/spaso Apr 6 2006 13:49:30
7800web 2469820 gweb/cpicweb 6.3.0/spaso Apr 6 2006 13:49:30
dkuweb 2488016 gweb/cpicweb 6.3.0/spaso Apr 6 2006 13:49:30
```

### Gdump

This utility program lists the Host Links environment. It is supplied as a character based utility `gdump` (UNIX/Linux binary) or `gdump.exe` (PC console application).

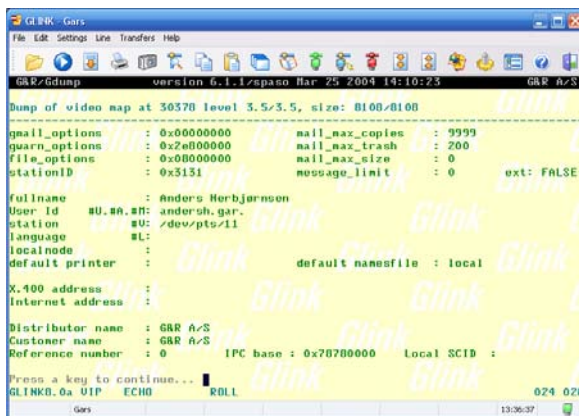

```
G&R/Gdump version 6.1.1zspaso Mar 25 2004 14:10:23 G&R A/S
Dump of video map at 30570 level 3.5x3.5, size: 8100x8100
-----
mail_options      : 0x00000000      mail_max_copies  : 9999
guard_options    : 0x2e000000      mail_max_trash   : 200
file_options     : 0x0B000000      mail_max_size    : 0
stationID        : 0x3131          message_limit    : 0      ext: FALSE

fullname         : Anders Herbjørnsen
User ID          : BU..NR..SH: andersh.gar.
station          : #U: /dev/pts/z11
language         : #L:
localnode        :
default printer  :                      default namesfile : local

X.400 address   :
Internet address:

Distributor name : G&R A/S
Customer name    : G&R A/S
Reference number : 0      IPC base : 0x707B0000      Local SCID :

Press a key to continue...
GLINK0.0a UIP ECHO RBLL 024 020
Gars 13:36:37
```



# Host print in DSA networks

---

## Print to screen session

If the application mixes print with normal screen output using print addressing for the print blocks, and screen addressing for screen blocks the DSA line module simply passes print output down to the Host Links emulator which in turn have numerous options that define how to handle it.

## Pthru

Print output delivered to a VIP7800 terminal must use the defined VIP7800 print control sequences, and the VIP7800 terminal interprets them. If you are using Glink it can be configured to print on the PC printer, a file, or the LAN-spooler. VIP7800 terminals must have an attached printer. Pthru will also map VIP-header print addressing to in-line print start and print stop sequences. VIP header print addressing is used by some applications written for synchronous VIP-terminals, and need to be mapped to in-line sequences for asynchronous terminals. The Pthru parameter for transparent print (`-PT`) can be turned off to inhibit this mapping.

## Qsim

Print output delivered to a synchronous Questar must use print addressing in the VIP-header, or embedded `ESC Z.....(US)` sequences. Qsim supports 'transparent print', which means that data blocks sent to the user workstation with print status in the VIP-header will be printed on the device configured as the print path (`-pp`) in Qsim (see *Qsim user guide*). This may be a physical UNIX/Linux printer, or a file. If it is a file it may be automatically delivered to the UNIX/Linux print spooler (`-pc` or `-pm`). Additionally, if the terminal has a printer attached or is a PC with Glink, the attached printer may be configured (`-pp *`). The PC printer in this case may be a real printer, or it may be a file, or the LAN-spooler.

## V78sim

Print output delivered to a 7800 terminal must use print addressing in the VIP-header, or embedded `CSI . . . p` sequences. V78sim supports both. The VIP-header print addressing is treated as 'transparent print', which means that data blocks sent to the user workstation with print status in the VIP-header will be printed on the device configured as the print path (`-pp`) in V78sim (see *V78sim user guide*). This may be a physical UNIX/Linux printer, or file. If it is a file it may be automatically delivered to the UNIX/Linux print spooler (`-pc` or `-pm`). Additionally, if the terminal has a printer attached or is a PC with Glink, then the attached printer may be configured (`-pp *`). The PC printer in this case may be a real printer, or it may be a file, or the LAN-spooler.

## Print on separate session

If mainframe print output is being sent to an independent mailbox then the DSA line module may be configured to merge this print with the terminal session. The resulting merged session looks to Glink or the Host Links emulators exactly as if the application had used print addressing. Please refer to the *Gline* manual for details of the `-pco` option. Alternatively a copy of Gspool can accept the print as described below.

## Gspool

If mainframe print output is being sent to an independent mailbox (not the user terminal, but a separate LID as used for a ROP-printer), then the Gspool product may be used to accept the print. Gspool functions quite independently outside of the user process and may be configured to connect to the mainframe, or to wait for the mainframe to connect to Gspool. Printers configured in DPF8-S&F must log on to GCOS8. Printers configured in RSM8 on GCOS8, in Twriter on GCOS7 and printers configured in the SNM on GCOS6 all wait for the mainframe to connect to them. There is no Remote Batch facility available in UNIX/Linux, so GCOS8 SYSOUT has to be delivered to Gspool via a GCOS8 SYSOUT spooling program such as RDF8, DPF8-DS, RSM8 or Dispatch8.

# Context Manager

---

## ***Multiple sessions***

Many users are in a situation where they consult/update several mainframe systems as well as running local applications, and often they would like to do this without terminating one mainframe session in order to start the next. If they are running a Windows PC with Glink, or some UNIX/Linux windowing system then this is no problem, they just open multiple windows. If they are running from a regular terminal the Host Links environment provides a user interface to the UNIX/Linux multitasking capability. In this case the user starts the Context facility, rather than the individual products, and all products are started from Context.

## ***General description***

Context is both a menu system and a program-switcher for the Host Links products. At startup it presents a user configurable menu, showing all available mainframe systems. By pressing one key, the desired product will be started, or switched to if already started. While executing one of the Host Links products, even while in a mainframe session, it is always possible to go back to the menu or to jump directly to another product with another mainframe session. When a Host Links product is terminated, the Context menu will be shown again. All active mainframe sessions are marked with the text "RUNNING". UNIX/Linux command level is also available from the menu. When Context is terminated all active mainframe sessions will be terminated. In this way Context provides multiple simultaneous mainframe connections with individual configuration of each mainframe session. Context can also be used to start other applications with or without the possibility to switch back to other entries in the menu. You always return to the menu when you terminate the application.

## How to start Context

Context is started by the command

```
context [-par] [-i n]
```

where the `-par` parameter tells Context to allow the user to edit the startup parameters interactively. The default is no display of the command line, and that all parameters have to be specified in the configuration files. The `-i n` parameter causes immediate start in context `n`.

E.g. `context -i 2`

Use of Context without `-par` looks better for the inexperienced user, and will as a desirable side effect disable the user from specifying his/her own parameters for the mainframe sessions. In this way the administrator will have full control of the configurations used.

## Moving between active contexts

When a Qsim session is started the user can always return to the Context manager by `LF #` or by quitting Qsim (`LF Q`). It is also possible to switch directly between the sessions with the key sequence:

```
LF <session number> #
```

In the same way the user can return from a Pthru session by command:

```
*$ $# [<session number>]
```

In addition to the Qsim and the Pthru sessions, the Context manager also allows the user to start other applications, and to escape to UNIX/Linux command level (if allowed in the `profiles` file).

If the other applications have the possibility of executing UNIX/Linux commands they may switch between contexts using the supplied utility `ctxsw`.

```
ctxsw n
```

as a UNIX/Linux command or from an application configurable menu. The application is suspended at that point, and will resume from there afterwards. The application must save and restore screen content.

When the user chooses to terminate the Context manager with the `Q` command, the Context manager will stop the sessions that have been left active, and clean up all resources used.

## ***Context configuration files***

By the use of a configuration file `context.cfg` Context allows configuration of command keys and command descriptions in the Context menu. Context allows user-specific configurations by first searching for the `context.cfg` file as follows:

```
/usr/gar/config/$LOGNAME/context.cfg
```

If this file or directory does not exist, Context will use the default file, which **MUST** exist:

```
/usr/gar/config/default/context.cfg
```

The default file is not used at all if the user has a private file.



The `context.cfg` file should have the following format:

```
Menu <command type><command><select_char><description>
  [<parameters>]
  [<parameters>]
```

where:

Menu	is a keyword in column 1, followed by directives with space (or tab) delimiters.
<command type> a	for a product using the video handler and context switching (Qsim/V78sim/G3270);
<command type> e	for all other program types.
<command>	is the name of the program to be started (e.g. Qsim or Pthru).
<select char>	is a character that will be used to select a line in the menu. Use numbers from 1 and upwards so the numbering in the context switching facility matches the position of the command in the menu.
<description>	can be any text describing the command.
<parameters>	are parameters for the product to be started. Parameters may start in any column, and several may be on the same line.

You should not put more parameters than necessary in `context.cfg`. General parameters for the products should be put their respective configuration files:

```
/usr/gar/config/[$LOGNAME|default]/pthru.cfg
/usr/gar/config/[$LOGNAME|default]/qsim.cfg
```

## ***Example of context.cfg***

```
Menu a qsim 1 Qsim session (IOF - GCOS7)
```

```
-mi m1  
-li dsa  
-ll 6144  
-du art  
-dp art  
-da iof  
-d? passw  
-dn en06
```

```
Menu a qsim 2 Qsim session 2 (TSS - GCOS8)
```

```
-li dsa  
-da tss  
-dn vd88
```

```
Menu a qsim 3 Qsim session 3
```

```
-li dsa  
-ll 6144
```

```
Menu e pthru 4 Pthru session 4 (TSS - GCOS8)
```

```
-li dsa  
-da tss  
-dn vd83  
-d? passw
```

```
Menu e pthru 5 Pthru session 5
```

```
-li dsa
```

```
Menu e pthru 6 Pthru session 6
```

```
-li dsa  
-ll 3000
```

```
Menu e vi 7 Program editor (vi)
```

```
/tmp/tmpfile
```

```
Menu a guft 8 G&R Unified file transfer
```





# Profiles configuration

---

## General

The profiles are used to set various parameters for customization of the Host Links environment for different users.

The profiles are read into the system each time a Host Links program is started by a non Host Links program, like the UNIX/Linux shell. A utility program called Gstart does this reading on behalf of the other products. This is all done automatically whenever you start a product.

## File location

All `PROFILES` files are located within special sub-directories within the Configuration directory. The Configuration directory is per default a directory `config` located in the System directory. The System directory is by default `/usr/gar`. This name may be overridden by setting the `GAR_SYSDIR` environment variable.

The format of the different `PROFILES` files is the same.

When Gstart starts, it first reads the default profile in order to establish defaults for users logging on. It then reads the profile belonging to the user logging on, and finally reads the system profiles file at the end.

## The *DEFAULT* profiles

Path name: `/usr/gar/config/default/profiles`

This `PROFILES` file is used to configure default settings for all users. It is possible to override these settings in the user profile (see below), so make sure that important settings that a user should not be able to override are defined in the system profiles file (see below).

The sample delivered is very simple, and defines all terminals as connected on eight bit lines:

```
* Sample default profiles file
* This file is read before the users and system profiles

eightbit
```

## The *USER* profiles

Path name: `/usr/gar/config/$LOGNAME/profiles`

This file is the user's private configuration file, and all settings that a user makes privately should go in here. The directory containing user configurations may be specified with the `CONFIGDIR` directive.

Typical content in the user's `PROFILES` file are special colors, preferred editors and file list programs.

## The *SYSTEM* profiles

Path name: `usr/gar/config/system/profiles`

This file is read after the two other `PROFILES` files to ensure that important settings that no user profiles should be able to override are enforced.

The sample file has no directives:

```
* Sample system profiles file
* This file is read after the default and users profiles
```

# File organization

Because Host Links is normally configured by an administrator, and is accessed by many users, the `PROFILES` file is organized in sections which may apply either to all users (the Default section), a group of users (the User section), specific stations (the Station section), a combination of the last two (the Station user section) or specific terminal types (the Termtypes section). Each section is prefaced with a header line:

```

DEFAULT
directive ...
.....

USER user[.account[.mode]]
directive ...
.....

STATION|TERMINAL station
directive ...
.....

STATIONUSER|TERMUSER station user[.account[.mode]]
directive ...
.....

TERMTYPE termtypes
directive ...
.....

```

Directives in the Default section apply to all users (stations) within the network. The directives in the User section only apply to those identified with a matching user ID. The user and account parts of the user ID are picked up from the UNIX/Linux log-in directly. The mode part of the user ID is set to the value of the `GAR_MODE` environment variable, if defined. Directives in the Station section only apply to the stations with a matching UNIX/Linux device name. Directives in the Termtypes section only apply to those with a matching `TERM` environment variable. Directives found later in the file will override those found earlier; thus you may include options for all users in the default section and reset them for some users later on in the file.

Blank lines and lines beginning with an asterisk (\*) are treated as comments.

## Directive format

The profiles file directives have the following format:

A directive begins with a keyword that identifies the command and it may have one or more arguments. Some of the arguments are interpreted by the G&R application; others may be intended for an external application and therefore passed on. The following arguments are interpreted by G&R:

Directive	Use
#A	will be expanded to the account part of the user id (user.account.mode).
#B	expands to nothing for compatibility with the <i>G&amp;R/Gmail</i> products
#C	will be expanded to the directory path name where the user's configuration files reside (/.../config/username).
#D	will be expanded to the working directory path name.
#F	will be expanded to the full path name of the current file.
#G	will be expanded to the user's full name.
#H	will be expanded to the home directory of the user.
#I	will be expanded to the help directory.
#L	will be expanded to the language currently in use.
#M	will be expanded to the mode part of the user id (user.account.mode).
#N	will be expanded to the file name of the current file.
#S	will be expanded to the System Directory.
#U	will be expanded to the user part of the user id (user.account.mode).
#V	will be expanded to workstation identification.
#Z	will be expanded to the extension part of the file name of the current file.
##X%	will be expanded to the contents of the environment variable X.

Directive	Use
##	will be replaced by a single # character.
*	asterisks are used to indicate various screen update classes, see below.

## Screen update classes

Various screen update classes are available, the class being specified by the number of asterisks before the command. The classes of commands are:

Asterisks	Meaning
None	The product clears the screen, displays the command, executes the command and, when the command terminates, waits for Enter before redisplaying the screen.
*	Same as None, except the product will not wait for Enter after executing the command.
**	The product will execute the command without clearing the screen or displaying the command, and update only the variable data afterwards (not the menu).
***	The product will not change the display, simply move the cursor to the bottom line while the command is executing.
****	The product will execute the command without clearing the screen or displaying the command, but will rewrite the screen.

For example the parameter

```
DIREEDIT vi #F
```

applies to Gdir. If you select the 'edit file' option in Gdir this parameter will cause it to start the UNIX/Linux file editor to edit the file presently being pointed at with the bar cursor. After the editor has terminated, you would have to press ENTER to continue. It is therefore better to configure an editor as a class 4 command, for example

```
DIREEDIT ****#B/gedit #F
```

This is the default value for Diredit, so if nothing is configured this command will be used.

## List of available directives

Directive	Default value
BWMODE	OFF
COLOUR	Change G&R product colours, see below
COLOURMODE	OFF
CONFIGDIR	#S/config/#%LOGNAME%
CURSORSIM	OFF
DIREDIT	****#B/gedit #F
DIRUSE	#S/config/default/diruse
DOLLAR	ON
EDIT	ON
EIGHTBIT	OFF
EXEC	ON
EXTENDED	OFF
HELPPDIR	#S/help
HOMEDIR	#%HOME%
KPAM	ON
KPNUM	OFF
LANGKEY	none
Language	none
LISTER	****#B/glist #F
MACRO	ON
MENU	ON
MISCDIR	#S/misc

Directive	Default value
SERVERDIR	#S/servers
SETUP	ON
SEVENBIT	OFF
Shell	ON
SOUND	ON
VIDEO	None. Overrides the TERM environment variable to choose a video handler
VIPGLINK	Modifies the VIP78 handler OFF, unless TERM starts with glink
VIPUNIX	Modifies the VIP78 handler OFF, unless TERM starts with glinkvip

## ***Description of the available directives***

### ***BWMODE – force colour off***

If you use the VIP78 video handler in Glink mode and don't want Glink to display colours then set this option.

```
BWmode ON    (default OFF)
```

### ***COLOUR – change default colour settings***

You may change the default foreground colours used by G&R applications. If you start *Gdir* you will see that the screen is divided into colour sections, starting at the top with the product header section which is normally white and inverse video. Then follows the menu section that is turquoise. Fourteen sections are defined all together. You may change one or several of these colour sections.

The format of the COLOUR directive is:

```
COLOUR sectionnumber colourcode
```

The section numbers range from 0 to 13. The product header is assigned to the number 0, the menu is assigned to 1 and so on.

The desired colour is specified with a colour code. The available colour codes are:

R(ed), B(lue), G(reen), T(urquoise), V(iolet),  
Y(ellow), W(hite), (blac)K, I(nverse), H(idden),  
F(lashing), U(nderline), L(ow intensity)

A colour may also be combined with Inverse and Low intensity code. For example, the directive

```
COLOUR 1 WL
```

will set the menu to white, low intensity.

Below are listed the section numbers together with the default setting and a short description of the sections.

```
COLOUR 0 WIL Product header
COLOUR 1 TL Menu
COLOUR 2 Y Menu attention
COLOUR 3 W Prompt
COLOUR 4 RI Field input
COLOUR 5 WU Header text
COLOUR 6 GL Data (normal)
COLOUR 7 RI Marked data
COLOUR 8 WL Information text
COLOUR 9 R Attention text
COLOUR 10 R Data red
COLOUR 11 W Data white
COLOUR 12 TL Data blue
COLOUR 13 Y Data yellow
```

## ***COLOURMODE – force colour on***

The VIP78 video handler in VIP7800 terminal mode and the VT200 video handler both default to black and white display only. This directive tells these video handlers to display in colour instead.



Colourmode ON (default OFF)

## ***CONFIGDIR directive – directory for user configurations***

This directive specifies the directory where all user configuration files are stored, for example the user's PROFILES file.

Note that two special configuration files, the Default and System PROFILES files, are stored in a fixed location under the #S/config directory. All user PROFILES files and other configuration files, however, are stored in the CONFIGDIR directory.

## ***CURSORSIM - software simulate cursor***

The TWS video handler normally lets the screen itself manage the cursor display. This directive make the video handler simulate it instead with inverse and underline attributes. Some people find this mode more visually pleasing.

```
CURSORSIM ON
```

## ***DIREEDIT directive – configure editor for Gdir***

With this directive you may configure the text editor to be used when you select the 'edit file' function in Gdir. If DIREEDIT is not configured, the G&R editor, Gedit, will be started.

#F will include the current file name.

```
DIREEDIT *vi #F
```

will start the vi editor with the file you are pointing at as argument.

## ***DIRUSE pathname – user command file for Gdir***

This directive specifies the name of the file containing the user commands for the directory utility, Gdir. The default value is a file named `diruse` located in your own configuration directory

```
./.../config/username/diruse
```

If this file does not exist, the `diruse` file in the default configuration directory

```
./.../config/default/diruse
```

is used. This default file is meant as an example only and should be modified.

You may share a DIRUSE file with other users or have one or more for your own usage. The following directive specifies that you have a DIRUSE file in your home directory named `mydiruse`.

```
DIRUSE #H/mydiruse
```

You can use `#A`, `#M` and `#U` in the specification of the DIRUSE file.

## ***DOLLAR – permission to enter directory manager***

This directive controls whether you are allowed to use the keys `LF $` to start the Gdir Directory Manager from the program you're executing, or not. It is a security consideration to allow this or not.

To disable this feature, use the directive

```
Dollar OFF
```

See also the `EXEC` and `SHELL` directives.

## ***EDIT - permission to run editor on screen image***

This directive controls whether the emulators allow you to start an editor on the current screen image. You can disable that feature by setting this directive `OFF`.

## ***EIGHTBIT - screen supports 8-bit characters***

Specifies that you want the extended character set (8-bit national characters) and the terminal is using a full 8-bit communications line. This is only supported for terminals with an 8-bit mode e.g. BDS, VT200 and the Glink emulator. UNIX/Linux systems must have parity and strip inhibited. Please note that older versions of Telnet often have the strip option set, and remove the top bit.

## ***EXEC – permission to execute commands***

This directive controls whether you are allowed to execute UNIX/Linux commands from the program you're running. It is a security consideration to allow this or not.

To disable this feature, use the directive

```
Exec OFF
```

See also the DOLLAR and SHELL directives..

## ***EXTENDED - 8-bit characters over 7-bit path***

Specifies that you want the extended character set (8-bit national characters) but the terminal is running in 7-bit mode on the communications line. This is supported only for the Questar (using SS2) and Glink (pseudo SS2). VT200, BDS and other terminals need an 8-bit line to use 8-bit characters

## ***HELDIR directory – help base directory***

The default base help directory is named `HELP` and is located in the System Directory. The base help directory may be placed elsewhere with this directive. If you enter a command in any G&R product, you may refer to the help directory with the `#I` convention.

You can use `#A`, `#M` and `#U` in the specification of the help base directory.

## ***HOMEDIR directory – users home directory***

The default home directory for a user is his UNIX/Linux home directory. You may set a permanent home directory with this directive. If you enter a command in any G&R product, you may refer to the home directory with the #H convention. For example, to copy the file you are pointing at in Gdir to the home directory using the same name you could enter the following command:

```
cp #F #H
```

If the name of the current file is `testfile` and your home directory is `/home/peter`, the above command would be expanded to

```
cp testfile /home/peter
```

You can use #A, #M and #U in the specification of the home directory.

## ***KPAM - keypad application mode***

Specifies that the VT200 video handler should default to do interpretation of function keys. `CTRL/N` may still be typed to change this while using the product. If KPAM mode is switched off the application mode sequences must then be interpreted by the Host Links product being used.

## ***KPNUM - keypad numeric mode***

Specifies that the VT100 and VT200 video handlers should default to interpret the number pad as sending numbers instead of function keys. `Ctrl/N` may still be typed to change this while using the product.

## ***LANGKEY xx - configure 7-bit screen language***

Turns on character transliteration for a specific country. It is normally used by 7-bit terminals to convert 7-bit national characters from the keyboard to 8-bit internally, and convert back to 7-bit for display. An extended or 8-bit terminal may use the option to view 7-bit national characters as 8-bit, but retain the 7-bit values internally.

The following keys are supported:

US	US ASCII (default)	SF	Swedish/Finnish	SP	Spanish
GB	UK ASCII	DE	Danish	IT	Italian
GE	German	NO	Norwegian	JA	JIS ASCII
FR	French				

Note that the value of the language key may also be toggled dynamically at any time using the `CTRL/F` key. The Default is US ASCII (no transliteration).

## ***LANGUAGE ccc – configure dialogue language***

Many G&R programs can operate with different languages, provided the correct language files are installed. Two files are needed for each language, the `progtxt[.ccc]` and the `messages[.ccc]` files, located in the `misc` directory subordinate to the `System` directory. The `ccc` file name extension indicates the language to use, and corresponds to the argument to the `LANGUAGE ccc` directive. The language key can be up to 3 characters long. Default is to have no specific language key.

For example, the directive to select French program texts is

```
LANGUAGE FR
```

## ***LISTER directive – configure file list program***

Many of the products use Glist as the default to display files. If you prefer another list utility you may configure it with the `LISTER` command. The default command is

```
LISTER ****#B/glist #F
```

`#B` expands to nothing and `#F` refers to the current file. The `****` is the standard G&R convention, telling the product that called the list command to update the whole screen as soon as the list command terminates without waiting for the user to enter a CR to continue. If you want to configure the UNIX/Linux `pg` command as the file list program, you should use the following configuration.

```
LISTER pg #F
```

The `pg` command terminates as soon as the complete file is displayed. With this update class the screen is not updated by `Gdir` until you type `ENTER` to allow you to read the last part of the file.

## ***MACRO - permission to define keyboard macros***

This directive controls whether the emulators allow you to define keyboard macros. You can disable that feature by setting this directive `OFF`.

## ***MENU – display program menus***

Most of the G&R applications have a menu in the upper part of the screen. By default this menu is always displayed. If you know the G&R products well, you may choose not to display these menus to give more room for the variable data.

You may at any time turn the menu on and off while running a G&R product with the `LF &` command, independent of the default you have configured in the `PROFILES` file.

## ***MISCDIR directory – miscellaneous file directory***

This directive specifies the directory where miscellaneous files are stored. These files are all necessary, and include character set transliteration tables `nnnn.chs`, program text files `progtxt[.ccc]` and status code explanations `messages[.ccc]`.

## ***SERVERDIR directory – directory for servers***

This directive specifies the top directory where configuration files for the various gateways and servers are stored. Please check the appropriate documentation for the different servers for details.

## ***SETUP - permission to run setup commands***

This directive controls whether the emulators allow you to change configuration parameters. You can disable that feature by setting this directive OFF.

## ***SEVENBIT - screen does not support 8-bit characters***

Resets the effect of `EXTENDED` and `EIGHTBIT`, for use when you want to specify, say, `EXTENDED` in the default section and override it for particular terminals. This is the default setting for the character set.

## ***SHELL – permit escape to shell***

This directive controls whether you are allowed to use the keys `LF !` to start a UNIX/Linux shell from the program you're executing, or not. It is a security consideration to allow this or not.

To disable this feature, use the directive

```
Shell OFF
```

See also the `EXEC` and `DOLLAR` directives.

## **SOUND – control alarm**

Most G&R applications sound the alarm to indicate error situations, e.g. if you press a key with no significance, or when the mainframe system ask an emulator to beep. You can disable the alarm bell by setting this directive `OFF`.

## **VIDEO handler - select video handler**

This directive may be used to select a video handler in the cases where the `TERM` variable is not set at all, or when, because of other UNIX/Linux applications, it has to be set to some specific value that Host Links doesn't recognize. The choices are currently:

<b>Handler</b>	<b>Used by</b>	<b>Default when TERM starts with</b>
VIP78	7800/BDS terminals and clones, Glink, other 7800 emulators	<code>glink</code> or <code>vip</code>
VT100	VT100 terminals and compatibles	<code>vt1</code>
VT200	VT200 terminals and compatibles	<code>vt2</code> . <code>vt3</code> or <code>vt4</code>
TWS	Async TWS and DKU terminals	<code>tws21</code> or <code>dku7</code>
TERM	All other terminals with a suitable <code>terminfo</code> description	Anything else

The `TERM` environment variable might have to be set to `vt220` because other UNIX/Linux applications test on the type, or have their own VT220 Terminfo file. A Glink user can still force use of the VIP7800 handler within the Host Links products:

```
VIDEO VIP78
```

Host Links will switch Glink to VIP7800 on entry, and back to VTnnn mode on exit.

The `TERM` environment variable might have to be set to `myterm` because the user has a special Terminfo for some UNIX/Linux application. By default Host Links will use the `TERM` handler, and use the `myterm` Terminfo to control the terminal. You can force the VT200 handler within Host Links:

```
VIDEO VT200
```





## ***VIPGLINK - VIP78 handler in Glink mode***

If you have to force the VIP78 handler using the `VIDEO` directive, you can enable the Glink extensions with this directive, it tells the VIP78 video handler that you're running Glink. If the `TERM` environment variable starts with `glink` then this is on by default.

## ***VIPUNIX - VIP78 handler can assume UNIX mode***

This directive tells the VIP78 video handler that the terminal is already in UNIX mode. For real 7800 and BDS terminals this means it is in so-called 'Character Attribute Mode'. For Glink it means the emulator is already running in VIP7800 emulation mode so switching from VT emulation mode need not be done. If the `TERM` environment variable starts with `glinkvip` then this is on by default.



# Video handlers

---

## General information

The Host Links video handlers are a series of compatible interfaces that allow G&R software products to communicate with any of the asynchronous terminals in general use. Handlers are available for Glink/VIP7800, DKU7102, TWS21xx, VT100 and VT200. There is also a handler that uses Termino to handle generic UNIX/Linux terminals. The correct handler is by default chosen based on the value of the `TERM` environment variable, but may also be explicitly chosen with the 'video' profiles directive, e.g. `'video vt200'`.

A video handler runs as its own process separate from the application process. Any Host Links product using a video handler will when started attempt to contact the appropriate video handler for the user terminal. If the video handler is not yet running it is started. The two processes then communicate through shared memory and pipes.

The set of screen update operations available to a product is in this way standardized, and any product that will run with one video handler will run with all of the others, giving considerable savings in development and testing, as well as a stable terminal handling environment

The keyboard read and screen update functions are quite asynchronous, with priority given in the products to processing keyboard input before doing screen update. This means that menus may be avoided by typing choices in advance of the menu display and that 'paging' in data or text can be short-circuited by paging again at any point during display of a page. The screen update will terminate immediately, and the new paging command will be executed.

Note that Pthru does not use a video handler. When it starts it takes control of the screen directly, handling the byte stream from the terminal itself.

## ***The VIP78 video handler***

This handler should be used for Glink as well as for Bull VIP78xx and BDS terminals or clones and emulations. The choice of VIP78 handler and behavior is best made using the `TERM` environment variable. A `TERM` variable starting with `'vip'` selects the handler for standard terminals, and one starting with `'glink'` selects the handler with the Glink specific features. A `TERM` variable of `'glinkvip'` leaves Glink in VIP78 mode when exiting to other UNIX/Linux applications, and is recommended. A `glinkvip` terminfo file is supplied to improve Glink/VIP78 mode performance in such cases. Any other `TERM` starting with `glink` assumes that Glink is started in VTnnn mode, but will switch Glink to VIP78 mode while in Host Links products, and then back to VTnnn on exit. A `glinkvt` Terminfo file is supplied to improve Glink VTnnn performance in such cases.

### ***VIP78 handler using terminals***

The profiles directive `'vipunix'` makes the handler assume the terminal is in UNIX mode, sometimes referred to as Character Attribute Mode, because attributes then follow characters rather than being set for fields. Omitting the directive makes the handler assume the terminal is in field attribute mode, which is supported by the video handler, but is not generally well supported by other UNIX/Linux applications. The profiles directive `'colormode'` enables color support, which is by default off for VIP7800 terminals.

### ***VIP78 handler using Glink***

The profiles directive `'vipglink'` selects the Glink specific features of the module. The `'vipunix'` directive causes Glink to be left in VIP78 mode when exiting to other UNIX/Linux applications, which is now recommended. Omitting the `'vipunix'` directive causes the video handler to switch Glink into VTnnn mode when exiting to other UNIX/Linux applications. The profiles directive `'bwmode'` disables color support, which is by default on for Glink.

The recommended way to log in to UNIX/Linux from a PC with Glink is now to run permanently in VIP78 emulation mode, by setting the TERM environment variable to `glinkvip` (usually by setting `glinkvip` as the Telnet terminal type response). The improved Terminfo file, `glinkvip`, for Glink in VIP78 mode (see below) ensures that commodity UNIX/Linux applications also function better.

## The TWS video handler

This handler should be used for the standard UNIX/Linux terminal in the Bull SA area, the TWS21xx, which emulates the previous Questar DKU7102 terminal used with the GCOS6 range. A TERM variable starting with `'tws21'` or `'dku7'` selects this handler.

The TWS video handler normally lets the screen itself manage the cursor display. The profiles directive `'cursorsim'` makes the video handler simulate it instead with inverse and underline attributes. Some people find this mode more visually pleasing.

## The VT100 video handler

This handler should be used with Digital VT100 terminals and clones and emulations of it. A TERM variable starting with `'vt1'` selects this handler.

The real VT100 family has only PF1 to PF4 function keys. Since most mainframe applications expect keys F1 to F12 with shift, as well as some other VIP and DKU specific keys, these must be defined in some way on the terminal. The VT100 handler by default uses this mapping:

VT100 key	Result	Result after O
KEYPAD 1	F1	SHIFT F1
KEYPAD 2	F2	SHIFT F2
KEYPAD 3	F3	SHIFT F3
KEYPAD 4	F4	SHIFT F4
KEYPAD 5	F5	SHIFT F5

KEYPAD 6	F6	SHIFT F6
KEYPAD 7	F7	SHIFT F7
KEYPAD 8	F8	SHIFT F8
KEYPAD 9	F9	SHIFT F9
KEYPAD ,	F10	SHIFT F10
KEYPAD -	F11	SHIFT F11
KEYPAD .	F12	SHIFT F12
KEYPAD ENTER	XMIT	
PF1	HOME	
PF2	ERASE TO END OF LINE	
PF3	ERASE TO END OF PAGE	
PF4	CLEAR	

'Result after 0' means that this is what happens if the keypad 0 key is pressed first, then the key in the left column.

The interpretation of the numeric keypad can be toggled from the above to numeric using the CTRL/N key. In numeric mode the keypad may be used for keying numbers. The initial state of this interpretation can be set to numeric by using the KPNUM profile directive.

## ***The VT200 video handler***

This handler should be used on Digital VT200, VT300 and VT400 terminals and clones and emulations of it. A TERM variable starting with 'vt2', 'vt3' or 'vt4' selects this handler.

The real VT200 family has 20 function keys but F1 to F5 are allocated to internal functions, and there are no shifted F-keys. Since most mainframe applications expect keys F1 to F12 with shift, as well as some other VIP and DKU specific keys, these must be defined in some way on the terminal. The VT200 handler by default uses this mapping:

VT200 key	Result	Result after 0
KEYPAD 1	F1	SHIFT F1
KEYPAD 2	F2	SHIFT F2
KEYPAD 3	F3	SHIFT F3
KEYPAD 4	F4	SHIFT F4
KEYPAD 5	F5	SHIFT F5
KEYPAD 6	F6	SHIFT F6
KEYPAD 7	F7	SHIFT F7
KEYPAD 8	F8	SHIFT F8
KEYPAD 9	F9	SHIFT F9
KEYPAD ,	F10	SHIFT F10
KEYPAD -	F11	SHIFT F11
KEYPAD .	F12	SHIFT F12
KEYPAD ENTER	XMIT	
PF1	HOME	
PF2	ERASE TO END OF LINE	
PF3	ERASE TO END OF PAGE	
PF4	CLEAR	
TAB	TAB	BACKTAB
FINISH	F4	SHIFT F4
INSERT	INSERT CHARACTER	INSERT LINE
REMOVE	DELETE CHARACTER	DELETE LINE
SELECT	SLC	
PREVIOUS SCREEN	PAGE UP	
NEXT SCREEN	PAGE DOWN	
F6	F6	

VT200 key	Result	Result after 0
F7	F7	
F8	F8	
F9	F9	
F10	F10	
F11	F11	
F12	F12	
F13	LF	
F14	v14	
HELP	F1	
Do	LF	
F17	RESET INITIALIZE	RESET
F18	SET ATTRIBUTE	DELETE ATTRIBUTE
F19	SET TABSTOP	DELETE TABSTOP
F20	ESCAPE	

By 'result after 0' is meant that this is what happens if the keypad 0 key is pressed first, then the key in the left column.

The keyboard interpretation can be changed using profile directives NOKPAM and KPNUM. The NOKPAM directive turns off all interpretation. The KPNUM directive interprets the numeric keypad as numeric so that it can be used for keying numbers. There are thus four possible states for the keyboard:

NOKPAM set and KPNUM not set. This gives little initial functionality, it does no VT200 keyboard mapping at all. The function keys deliver native VT200 sequences, the numeric keyboard sends the sequences associated with application mode, and these too are delivered as native VT200 sequences. The mode relies on a keyboard definition in the Host Links product to assign the native VT200 key sequences to functions in the product. The functions assigned will vary by product and are set for each product. See the *Qsim*, *V78sim* or *G3270 manuals* for examples of keyboard definitions. By default they all recognize the Host Links command key which is placed on F16 (Do).



NOKPAM is set and KPNUM is set. This is just as the above, except that the numeric keypad is interpreted as numeric and can be used to key numbers.

NOKPAM is not set, and KPNUM is not set. This is the default as shown in the table above. This gives maximum mapping of the keyboard into keys needed by Host Links products.

NOKPAM is not set and KPNUM is set. This gives the mapping in the table above, except that the numeric keypad is used to enter numbers.

The CTRL/N key can be used to toggle between the modes described above. For each press of CTRL/N the keyboard interpretation steps to the next mode. The mode is indicated with a status message.

The profiles option COLOURMODE allows the video handler to send ANSI colour sequences which are interpreted by VT340, and also many VT220 clones.

## ***The term video handler***

This handler must be used on any terminal not supported by any of the specialized handlers described in the previous paragraphs. A TERM variable with any value other than those mentioned previously will select this handler.

This handler relies on the Terminfo description of the specific terminal. We will not try to teach you how to write Terminfo descriptions from scratch here. Below you will however find a summary of what Terminfo entry labels are used for keyboard input by the term video handler, as well as what is required to be set or not set. All the other Terminfo labels for cursor motion, screen output, attributes, graphics etc. are handled in the obvious way by the video handler. In many cases the Terminfo entries delivered with the system will work reasonably well. Some amount of tweaking is normally necessary in order to get perfect results for the keyboard handling.

Terminfo label	Comments
gn, hc, xhp, hz, xmc	Required to not be set
cup, ill, dll, clear, el, ed, sgr, sgr0	Required to be set

Terminfo label	Comments
kcud1	Key, Cursor down
kcuu1	Key, Cursor up
kcub1	Key, Cursor left
kcuf1	Key, Cursor right
khome	Key, Cursor home
kbs	Key, Backspace. Comes in addition to a hard-coded default of 0x08
kf63, kext	Key, ESC. If neither kext nor kf63 are defined a hard-coded default of 0x1b 0x1b is used
kf58, ktab	Key, Tab. Comes in addition to a hard-coded default of 0x09
kf59, krdo, kcmd	Key, LF. Comes in addition to a hard-coded default of 0x0a
ksf, knp	Key, Page down
ksr, kpp	Key, Page up
kf1..kf12	Key, Function key F1..F12
kf13..kf24	Key, Shifted function key F1..F12
kf21..kf32	Key, Shifted function key F1..F12. Only if kf13..kf24 isn't defined. If neither kf13..kf24 nor kf21..kf32 are defined a hard-coded default of ESC1, ESC2, ESC3, ESC4, ESC5, ESC6, ESC7, ESC8, ESC9, ESC0, ESC q, ESC q is used
kf60, khlp	Key, Help. Really works the same as F1 in most applications
kdch1	Key, Delete character
kich1	Key, Insert character
kdll1	Key, Delete line
kill1	Key, Insert line
kclr	Key, Clear

Terminfo label	Comments
kf62, kel, kend	Key, Erase to end of line or move to end of field
ked	Key, Erase to end of screen
kf0, kext	Key, Transmit
kf61, kbtabs, kcbs	Key, Back tab
krmir	Key, Paste character
khts	Key, Tab set
kctab	Key, Tab clear
ktbc	Key, Clear all tabs
kf57, kcan	Key, Reset to initial state
kf56, kCAN	Key, Reset
kf55	Key, Set attribute
kf54	Key, Delete attribute

After you have edited your Terminfo entry you must run it through `tic`, the Terminfo compiler. The exceptions are systems running Hewlett-Packard HP-UX 10.x, here the command is called `tic_colr`.

## ***Terminfo files delivered***

Terminfo definitions for Glink in VIP78 and VT modes (`glinkvip`, `glinkvt`), the X11 Window System's `xterm` program (`xtermgar`), the CDE (Common Desktop Environment) program `dterm` (`dttermgar`) and FTP Software Inc.'s PC-TCP Telnet program (`pctcpgar`) are included. The Glink Terminfo definitions are not needed by Host Links when running in VIP78 mode as recommended. They are included for the benefit of those using Glink to run other UNIX/Linux applications. The `xtermgar`, `dttermgar` and `pctcpgar` definitions are needed in order to enable all features of Host Links when run from these respective terminal emulators.

If any of the above applies to you then you need to compile the right Terminfo file for your operating system. The Terminfo files are all placed in the directory `/usr/gar/install/terminal`. Go there, then `su` to the super user identity, then run the command:

```
tic xxx.ti
```

Where `xxx` is `aix3` on the `rs6ai` platform, `aix4` on `rs6a4`, `mono` on `spasu`, `old` on `hppux` and `hppu1`, `rcolor` on `386v3`, `386v4` and `mipv4` and `color` on all the others. Additionally on the `hppu1` platform run the command:

```
tic_colr color.ti
```

## ***Extra setup for the X11 xterm program***

For Sun Solaris 2.x:

```
cat xtermgar.res >> /usr/openwin/lib/app-defaults/XTerm
```

For most other systems:

```
cat xtermgar.res >> /usr/lib/X11/app-defaults/XTerm
```

Be careful to get this command right, it appends the `xtermgar.res` file to the end of the existing `app-defaults/XTerm` file. Note the use of two `>` characters and that `XTerm` at the end is spelled with a capital `X` and `T`.

Some of the keyboard mappings cannot be guessed, here's an overview of the ones that aren't intuitive:

<code>CTRL-HOME</code>	Clear
<code>CTRL-PGDN</code>	Erase to end of page
<code>CTRL-END</code>	Erase to end of field
<code>CTRL-INSERT</code>	Insert line
<code>CTRL-DEL</code>	Delete line
<code>CTRL-PGUP</code>	Reset
<code>KEYPAD +</code>	Transmit
<code>KEYPAD -</code>	LF

Finally you need to know how to actually start the `xterm` window with our extra keyboard mappings enabled. After you have done the above, the only trick needed is to include one extra option on the `xterm` command line:

```
-name xtermgar
```

## ***Extra setup for the CDE dtterm program***

First append the supplied X resource file to the standard Dtterm resources:

```
cat dttermgar.res >> /usr/dt/app-defaults/C/Dtterm
```

Be careful to get this command right, it appends the `dttermgar.res` file to the end of the existing `app-defaults/C/Dtterm` file. Note the use of two greater than (>) characters and that the directory `C` and file `Dtterm` at the end are spelled with an upper case `D`.

Some of the keyboard mappings cannot be guessed, here's an overview of the ones that aren't intuitive:

<code>CTRL-HOME</code>	Clear
<code>CTRL-PGDN</code>	Erase to end of page
<code>CTRL-END</code>	Erase to end of field
<code>CTRL-INSERT</code>	Insert line
<code>CTRL-DEL</code>	Delete line
<code>CTRL-PGUP</code>	Reset
<code>KEYPAD +</code>	Transmit
<code>KEYPAD -</code>	LF

Finally you need to know how to actually start the `dtterm` window with our extra keyboard mappings enabled. After you have done the above, the only trick needed is to include one extra option on the `dtterm` command line:

```
-name dttermgar
```

## ***Extra setup for the FTP Software TN.EXE program***

Copy the `pctcpgar.map` file into the directory where the PC has its PC/TCP configuration files, typically the same directory that contains `PCTCP.INI`.

Edit the `PCTCP.INI` file. In the section labeled `[pctcp vt]`, add these two lines:

```
vt220-keymap = c:\pctcp\pctcpgar.map  
vt220-terminal-id = pctcpgar
```

(c:\pctcp or wherever you placed it)

That's all. Now just run the `TN.EXE` program as usual, no extra options should be needed.

# Interactive commands

---

The video handlers accept certain commands while in execution. The commands are given as ASCII control characters by holding down the `CONTROL` key on the terminal and typing a character between '@' and '\_' in the US ASCII character set.

The commands are as follows:

- |                     |  |
|---------------------|--|
| <code>CTRL/F</code> | Toggle language key. The mapping to/from the extended character set will be stepped through the available ISO substitution sets. The chosen set is displayed in line 24 of the screen. US ASCII gives no mapping.                    |
| <code>CTRL/I</code> | Horizontal tab. For terminals with no <code>TAB</code> key.  |
| <code>CTRL/J</code> | Line Feed. For terminals with no <code>LF</code> key.  |
| <code>CTRL/K</code> | Copy field from screen. The characters between the cursor and the next attribute change on the screen (or the end of the line) are copied.   |
| <code>CTRL/L</code> | Redisplay the entire screen.   |
| <code>CTRL/N</code> | Select between different function key and keypad modes in the VT100 and VT200 handlers.  |
| <code>CTRL/P</code> | Hard copy of screen. The screen content is saved on your home directory with file name <code>screen.sav</code> in plain text format.   |
| <code>CTRL/U</code> | Paste field. The field previously copied with <code>CTRL/K</code> is inserted as keyboard input at the cursor position. You should be at a place where it would be logical for you to type the content of the field you have copied. |
| <code>CTRL/Z</code> | Back tab. For terminals with no back tab key.  |

Other `CTRL` sequences may be allowed through for interpretation by the product using the video handler, and in this case will be accepted or not at the application level.







# ***Character sets***

---

## ***Limitations of the 7-bit set***

Data processing terminals have often only the 7-bit ASCII character set, standardized by ISO 646. This gives 128 combinations of possible characters, but the first 32 and the last are reserved as ASCII control characters. Because we need 1 character as a 'space' there are 94 possible displayable characters. In this set there are 12 characters reserved for national interpretation, marked in the following table by bold numbering.

## ***National substitutions***

Please note that your view of these tables will be decided by the ability of your printer or screen to represent the full character set.

ISO have standardized substitution sets for several languages, and these are given in the table above. Of course all of them are used for different purposes in all languages.

hex	0	1	2	3	4	5	6	7
0	null.		0	3	P	8	p	
1	.	!	1	A	Q	a	q	
2	.	"	2	B	R	b	r	
3	etx	.	1	3	C	S	c	s
4	.	.	2	4	D	T	d	t
5	.	.	%	5	E	U	e	u
6	.	.	&	6	F	V	f	v
7	bel	.	'	7	G	W	g	w
8	bs	.	(	8	H	X	h	x
9	ht	.	)	9	I	Y	i	y
A	lf	.	*	:	J	Z	j	z
B	vt	esc	+	;	K	4	k	9
C	ff	.	,	<	L	5	l	10
D	cr	.	-	=	M	6	m	11
E	so	rs	.	>	N	7	n	12
F	si	us	/	?	O		o	.

N	hex	U	G	G	F	S	D	N	S	I	J
r		S	B	E	R	F	E	O	P	T	A
1	23	#	£	#	£	#	#	£	£	#	
2	24	\$	\$	\$	\$	\$	\$	\$	\$	\$	
3	40	@	@	\$	à	É	É	@	\$	\$	@
4	5B	[	[	Ä	°	Ä	Æ	Æ	;	°	[
5	5C	\	\	Ö	ç	Ö	Ø	Ø	Ñ	ç	¥
6	5D	]	]	Ü	\$	Ä	Ä	Ä	¿	é	]
7	5E	^	^	^	^	Ü	Ü	^	^	^	^
8	60	`	`	`	`	é	`	`	`	ù	`
9	7B	{	{	ä	é	ä	æ	æ	°	à	{
10	7C			ö	ù	ö	ø	ø	ñ	ò	
11	7D	}	}	ü	è	ä	ä	ä	ç	è	}
12	7E	~	~	ß	.	ü	ü	~		i	~

US American            DE Danish  
 GB British             NO Norwegian  
 GE German             SP Spanish  
 FR French             IT Italian  
 SF Swedish            JA Japanese

Thus the character hex 5B is an American [, French °, German Ä, and Norwegian Æ. This means that when using this character set, any exchange between countries of text containing national characters is virtually impossible. However it is possible to work in this character set within the boundaries of one country, and terminals are sold within the European countries with 'national' keyboards with the national characters allocated as explained above, and with interpretation of these characters to display the national characters on the screen.

Host Links supports this mode of operation with the limitations as described, and users may continue to use the data processing character set if they wish. However for users wishing to use national characters, while retaining the international interpretation of the 7-bit set, or for users who wish to produce multilingual text, the product range offers the possibility of working with an extended character set.

## The 8-bit standard

Internally the Host Links platforms use 8 bits per character, giving 256 possible combinations. The assignment of characters to the combinations is done using the direct coding representation in accordance with the ISO standard 8859/Part 1, known within Bull as the D.011 PLW (Plurilingual West) standard. This means that the characters needed for general office work may be coded as one byte for all of the following languages:

Danish	Faeroese	German	Italian	Spanish
Dutch	Finnish	Icelandic	Norwegian	Swedish
English	French	Irish	Portuguese	

Additionally, because Host Links supports the use of the line graphic characters in text, the 11-line graphic characters have been allocated a place in the character set. If this extended character set is used then text can be freely exchanged between the countries mentioned with no confusion as to interpretation of national characters.

Users with word processing keyboards, or with data processing keyboards with possibilities for extension are able to key most of the national characters directly from the keyboard. Technically this is possible if the terminal has an 8-bit connection and supports the international set. For 7-bit connections some terminals e.g. the DKUs (Questar) in word processing mode and *Glink* can still use the 8-bit set, because the terminal sends two or three 7-bit characters corresponding to one national character (e.g. e with a grave accent) and this is interpreted by the video handler and delivered as one 8-bit character.

For terminals not having this possibility the administrator may configure a language key in the user profile to transliterate national 7-bit characters to 8-bit (see the LANGKEY profile directive).

# Host Links character set

Note that the printer on which the documentation is printed will affect your view of the following table. Because this table is to be formatted and printed the ASCII control characters have been removed, and a period substituted. Generally ASCII control characters should never be used in files to be formatted and printed.

dec	0	1	3	4	6	8	9	1	1	1	1	1	2	2	2	
		6	2	8	4	0	6	1	2	4	6	7	9	0	2	4
								2	8	4	0	6	2	8	4	0
hex	0	1	2	3	4	5	6	7	8	9	A	B	C	D	E	F
0	.	.		0	@	P	`	p		.		°	À	Ð	à	ö
1	.	.	!	1	A	Q	a	q		.	ı	±	Á	Ñ	á	ñ
2	.	.	"	2	B	R	b	r		.	ç	²	Â	Ò	â	ò
3	.	.	#	3	C	S	c	s	┌	.	£	³	Ã	Ó	ã	ó
4	.	.	\$	4	D	T	d	t		.	¤	´	Ä	Ô	ä	ô
5	.	.	%	5	E	U	e	u	└	.	¥	µ	Å	Õ	å	õ
6	.	.	&	6	F	V	f	v	—	.		¶	Æ	Ö	æ	ö
7	.	.	'	7	G	W	g	w	┘	.	§	·	Ç	×	ç	÷
8	.	.	(	8	H	X	h	x		.	¨		È	Ø	è	ø
9	.	.	)	9	I	Y	i	y	└	.	©	¹	É	Ù	é	ù
A	.	.	*	:	J	Z	j	z	└	.	ª	º	Ê	Ú	ê	ú
B	.	.	+	;	K	[	k	{	┘	.	«	»	Ë	Û	ë	û
C	.	.	,	<	L	\	l		┘	.	¸	¼	Ï	Ü	ï	ü
D	.	.	-	=	M	]	m	}	┘	.	½	½	Í	Ý	í	ý
E	.	.	.	>	N	^	n	~	┘	.	¾	¾	Î	Þ	î	þ
F	.	.	/	?	O		o	.	┘	.	—	¿	Ï	ß	ï	ÿ

# Using the 8-bit set

---

## **8-bit terminals (EIGHTBIT)**

Many terminal types have an 8-bit connection to the Host Links platform and need no mapping mechanism. They send 8-bit characters as single characters on the 8-bit connection. The video handlers support the 8-bit interface with the `EIGHTBIT` profile. If your terminal or terminal emulator supports the ISO 8-bit character set then you should configure for eight bit.

## **7-bit terminals with mapping (EXTENDED)**

Some terminal types (see below) have a mapping mechanism for transmitting 8-bit characters over 7-bit lines. The profile directive `EXTENDED` informs the video handler if the extended character set is wanted. If it is, then video handler interprets each 8-bit character from the product and sends the correct series of 7-bit characters to the screen, where they are again interpreted as a single character, and displayed. Keyboard input of 8-bit characters is mapped into a series of 7-bit characters by the terminal, and the handler interprets them as one 8-bit character. This is only supported for terminals with a mapping mechanism.

## **Glink**

When running the Glink terminal emulator on a 7-bit line the `gv_vip78` video handler uses a simplified SS2 mechanism to reach the full character set if `EXTENDED` is configured. Glink transliterates this into the PC character set to give a correct display on the PC monitor, including the line-graphic characters. Keyboard input is mapped in a similar way to the intended 8-bit character by the *Glink* terminal simulator, and then sent as a simple SS2 sequence to the `gv_vip78` video handler. The video handler interprets the SS2 sequence as a single 8-bit character.

## **The DKU7102 (TWS21xx)**

The Questar DKU7102 is a 7-bit terminal, but if the setup menu of the terminal is configured for a Word Processing keyboard (SW 13) then it uses the SS2 mapping mechanism and the video handler (`gv_tws`) may be configured to use the extended character set (`EXTENDED`). In this case the video handler will itself turn on the extended character set in the setup menu by command (SW 14) whenever it connects to the terminal, and interpret all SS2 (single shift 2) sequences from the terminal as being single 8-bit characters. Similarly each 8-bit character is mapped to an SS2 sequence for display on the screen. See the Questar reference manual for details. The DKU7102 in extended mode can actually display the ASCII control characters 'SOH', 'STX' etc. which is very helpful.

## **7-bit terminals (LANGKEY)**

### **Display of 8-bit characters**

Many old-style terminals are 7-bit only, and have a national keyboard and screen that interprets and displays the 7-bit ISO substitution characters as national characters. For terminals without extended character sets the following rules are used when displaying 8-bit characters:

- National characters with a 7-bit equivalent in the data processing set are displayed as the 7-bit equivalent. This means that a user with an extended keyboard may send a message to a German user with a 7-bit national terminal. The 'real' national characters (e.g. Ü - hex DC) would be transliterated by the video handler to the 7-bit national characters (i.e. ] - hex 5D), but displayed 'correctly'. Of course the same message displayed on a Norwegian 7-bit national terminal would be 'incorrect' because exactly the same 7-bit characters are used to display Norwegian national characters (i.e. Å - hex 5D).
- National characters with accents, but with no national equivalent are displayed without the accent.
- Extended characters that do not exist in the 7-bit set (for example, the ¼ (hex BC)) are displayed as a period ".".

## Entering 8-bit characters

These terminals have no way of generating 8-bit characters. The national characters on the keyboard generate the 7-bit national equivalents. However if you want to work internally in Host Links with 8-bit national characters you may use the LANGKEY profiles directive to transliterate keyboard input according to one of the national substitution sets. For example, a German user with LANGKEY GE in his profile, could type the German national characters as follows:

National character	#	\$	<b>ſ</b>	<b>Ä</b>	<b>Ö</b>	<b>Ü</b>	^	`	<b>ä</b>	<b>ü</b>	<b>ß</b>
US ASCII value	#	\$	@	[	\	]	^	`	{		}
Hex character	23	24	A7	C4	D6	DC	5E	60	E4	FC	DF

The handler transliterates the bold characters to the correct 8-bit character, even though the terminal keyboard generated the US ASCII characters.

In order to input a real 7-bit character e.g. the left square bracket '[', the user would have to dynamically toggle the language key to US ASCII using the CTRL/F command to the G&R video handler.

## 8-bit terminals viewing 7-bit characters

Users with extended character sets EXTENDED/EIGHTBIT but working in an environment with many 7-bit terminals, and where the 7-bit terminals are not using LANGKEY in the profiles, will see the national substitution characters in the true US ASCII format. This may make text difficult to read.

### Default national view

If much of the text you view is in your local 7-bit national character set you can use LANGKEY in your own profile. The result of this is that the video handler shows both the 8 bit national characters and the 7-bit equivalents as extended characters, making it possible to read text written by '7-bit users'.

## ***Toggle to national view (CTRL/F)***

If you occasionally view text that is in some 7-bit national set then you can temporarily toggle your language key to the correct 7-bit set using the video support for CTRL/F language selection. Each time you type CTRL/F the video handler will step the character set interpretation to the next language. If you then redisplay the text on your screen it will be shown with the national interpretation of the 7-bit national characters.

## ***Data entry while viewing 7-bit***

While in this mode keyboard input of 7-bit characters from the 8-bit terminal would still be stored internally as 7-bit characters, but would be displayed as national equivalents.



# Appendix: Host Links Manuals

---

Below you find a complete list of all available Host Links manuals:

<b>Installation</b>	
Host Links Servers	Installation and Configuration on UNIX/Linux
Host Links Emulators	Installation and Configuration on UNIX/Linux
Host Links	Installation and Configuration on Windows
<b>Line handling</b>	
Gline	Line Handler and DSA/OSI Configuration
Ggate	Transparent Gateway
Gproxy	Network Manager & SNMP Proxy Agent
G&R SSL	Using SSL for security in G&R products
GIAPI	Application Programming Interfaces
<b>Emulations</b>	
Gspool	Network Printer Emulation
GUFT	Unified File Transfer
G3270	Emulating IBM 3270 Terminals
G5250	Emulating IBM 5250 Terminals
Pthru	Gateway to the Bull Primary Network
Qsim	Emulating Questar DKU7107-7211 & VIP7700-7760
V78sim	Emulating VIP7801 & VIP7814
Gweb	Web Browser Front-end for DKU, VIP7700-7760, VIP7800, IBM3270 and IBM5250 Emulations



# Appendix: The text library

---

All the messages used by Host Links are kept in the text library `progtext[.ccc]` in directory `gar`, sub-directory `misc`, so the default texts for a site can be changed using the `gcptexts` utility:

## ***gcptexts - Maintain program texts***

```
gcptexts [-v] [-x module] [-o] library [[file] [file]..]
```

where                    <library> is progtext with all module texts  
      <module>            is a text module number to export, or 0 for all  
      <file>              are the files containing program texts to import

Flags -v                verbose mode  
      -o                overwrite ok when exporting

The host Links modules using the message library are:

Module	number for export
divutl	001
gdir	011
gedit	016
gline	006
glist	013
gmail	012
gmailer	015
gmenu	014
guft	028
gweb	030
mailutl	002

The texts are exported to one file for each module, where the file name is fixed and the same as the module name e.g. file 'gline':

```
#006 Attention: Do NOT modify this line!  
001 You are not logged on to the gateway.  
002 You are already logged on to the gateway.  
003 You are not connected.  
004 Already connected.  
005 -LL parameter out of range.
```

Export the message texts used by Gline (module 6) to file 'gline':

```
gcptexts -v -x 6 progtext
```

Modify the file (not the first line identifier) and then import the messages. You can import from multiple files using any file names:

```
gcptexts -v progtext myglinetexts mygwebtexts
```

Note that you can have several different `progtext` libraries, and select the one to be used by adding a `LANGUAGE` directive to the profile used by an individual user or group of users. The libraries are identified by a suffix of up to three characters e.g. `progtext.fr`, and this would be selected by adding the directive `LANGUAGE FR` in the profile. See the chapter entitled *Profiles configuration* for details. The default is `progtext` with no suffix, and if all users speak the same language you can simply update `progtext` with your translated version of the texts.

# Appendix: Error Codes

---

## OSI/DSA error codes

Below is a list of OSI/DSA error codes and the corresponding description. These are the same descriptions that the G&R/Gerror utility will display when given the DSA code as a parameter.

code	Description
<b>00xx</b>	<b>General Errors</b>
0001	Open Failure in LC - Reject for unknown reason
0002	Open Failure in LC - Acceptor customer node inoperable
0003	Open Failure in LC - Acceptor customer node saturated.
0004	Open Failure in LC - Acceptor mailbox unknown.
0005	Open Failure in LC - Acceptor mailbox inoperable.
0006	Open Failure in LC - Acceptor mailbox saturated.
0007	Open Failure in LC - Acceptor application program saturated
0008	Connection refused. Transport protocol error or negotiation failed.
0009	Open Failure in LC - Dialog protocol error or negotiation failed
000A	Open Failure in LC - Presentation protocol error or negotiation failed
000B	Open Failure in LC / Connection refused lack of system resources
000C	Open Failure in LC / Connection refused from GCOS7 duplicate user
000D	Open Failure in LC, Duplicate implicit LID / Q class not started
000E	Open Failure in LC, Duplicate GRTS Id / lack of memory resources
000F	Open Failure in LC, No Logical line declared for DACQ / 7 connection refused
0010	Open Failure in LC, GCOS 8 GW Missing translation / Incorrect device length in ILCRL.
0011	Open Failure in LC, DAC connection not initialized / Too many jobs executing
0012	Open Failure in LC, No binary transfer / impossible to start the IOF job
0013	Open Failure in LC, connection is not negotiated in FD mode / impossible to start the IOF job

0014	Disconnection - Timeout resulting from absence of traffic.
0016	Option missing for an RBF mailbox.
0017	Connection refused - Incorrect access right for MB.
0018	Connection refused - Incorrect access rights for the application.
0019	Connection refused - Unknown pre-negotiated message path
001A	Connection refused - Security validation failed.
001B	Connection refused - Unknown acceptor mailbox extension.
001C	Connection refused - Inoperable acceptor mailbox extension.
001D	Connection refused - Invalid Message group number.
001F	Disconnection - no more memory space.
0020	Connection refused - Unknown node.
0021	Connection refused - inaccessible node or Host down.
0022	Connection refused - saturated site.
0023	Connection refused - inoperable mailbox.
0024	(X.25) Packet too long. Problem with packet size. / Connection block already used.
0030	Syntax Error - option not known (received on close VC).
0031	(X.25) No response to call request packet - timer expired.
0033	(X.25) Timer expired for reset or clear indication.
0039	Disconnection - transport protocol error (MUX).
003C	Presentation Control Protocol Error
003E	The application has not the turn
003F	Message group closed
0040	(X.25) Facility code not allowed. / Connection refused - unknown node
0041	Connection refused - path not available.
0042	Connection refused - Duplicate USER ID / Facility parameter not allowed
0044	(X.25) Invalid calling address.
0045	(X.25) Invalid facility length.
0047	(X.25) No logical channel available.
004F	DNSC: (X.25) Invalid call packet length.
0050	Normal disconnection (GCOS3/8)
0051	Error or Event on LC initiated by GW
0052	Error or Event on LC initiated by GW.
0053	Error or Event on LC initiated by GW. TCall
0054	Error or Event on LC initiated by GW. DIA in LOCK State
0055	Error or Event on LC initiated by GW. DIA error
0056	Error or Event on LC initiated by GW. GW has no known explanation.
0057	Error or Event on LC initiated by GW. Reject mailbox permanent

0058	Error or Event on LC initiated by GW. No more input lines in DACQ
0059	Time-out on GCOS 3/8 gateway.
005A	Error or Event on LC initiated by GW. Disconnect from terminal without reason
005B	Error or Event on LC initiated by GW. Wrong letter or wrong record
005C	Error or Event on LC initiated by GW. Forbidden letter received
005D	Error or Event on LC initiated by GW. Forbidden letter received
005E	Error or Event on LC initiated by GW. No buffer for secondary letter
005F	Error or Event on LC initiated by GW. No buffer for fragmented letter
0060	Error or Event on LC initiated by GW. Disconnect on end of phase record
0061	Error or event on LC initiated by GW. No buffer for control letter.
0062	Error or event on LC initiated by GW. Mailbox in closing phase
0064	Error or event on LC initiated by GW. Flow control error.
0065	Error or event on LC initiated by GW. CH locked by operator.
0066	Error or event on LC initiated by GW. Disconnect with a normal TMG F2 exchange.
0067	Error or event on LC initiated by GW. Teletel rerouting error from DACQ
0068	Error or event on LC initiated by GW. Teletel routing error from DACQ
0069	Error or event on LC initiated by GW. Teletel rerouting error from TM
006A	Error or event on LC initiated by GW. Teletel rerouting error from TM
006B	Syntax error - text too long.
006C	Syntax error - illegal object in a GA command.
006D	Syntax error - unknown node Id.
0078	Syntax error - illegal command for this object.
0079	Syntax error - illegal date.
007F	(X.25) No route available for X.25 switching.
0081	No more network routes available for switching.
0082	(X.25) Hop count reached for X.25 switching.
0083	(X.25) Flow control negotiation error.
0085	(X.25) Frame level disconnection.
0086	(X.25) Frame level connection.
0087	(X.25) Frame level reset.
0090	Frame level not set.
0092	(X.25) X.25 Echo service in use.
0093	(X.25) Incorrect password for PAD connection.

0094	(X.25) No more PAD connections allowed.
0096	(X.25) TS SX25 or NU X25 objects locked.
009C	(X.25) Invalid packet header. X.25 protocol error.
009D	(X.25) Incompatible header. X.25 protocol error.
009E	(X.25) Logical Channel Number too high.
009F	(X.25) Incorrect packet type.
00B2	Use of invalid password through PAD
00B6	Unknown mailbox selection for PAD connection using the PAD password.
00C0	(X.25) Normal disconnection.
00D7	(X.25) TS image (of type DSA or DIWS) in LOCK state.
00DE	(X.25) NS RMT or NR SW in LOCK state.
00E1	Connection refused. Mailbox is not in ENBL state.
00E6	QOS not available permanently.
<b>01xx</b>	<b>Session Control</b>
0100	Logical connection accepted or normal termination
0101	Rejection for unknown reason or abnormal termination
0102	Acceptor node inoperable.
0103	Acceptor node saturated. When a node has no available resources
0104	Acceptor mailbox unknown.
0105	Acceptor mailbox inoperable.
0106	DNS: Acceptor mailbox saturated.
0107	DNS: Acceptor application program saturated.
0108	Transport protocol error or negotiation failed (DSA 200 only).
0109	Dialog protocol error or negotiation failed. (Wrong logical record).
010A	Time-out on session initiation / unknown LID
010B	Acceptor mailbox extension unknown.
010C	Acceptor mailbox extension inoperable.
010D	Invalid Session Number.
010E	Unknown node.
010F	System error. System generation error or insufficient memory space
0110	Application abnormal termination. Subsequent to an abnormal occurrence in the dialogue
0111	Normal terminate rejected.
0112	Protocol not supported.
0113	Session control service purged by user.
0115	Disconnection Time-out on message group initiation.
0117	Incorrect Access Right for MB
0118	Incorrect Access Right for the Application
0119	Pre-negotiated Message Path Descriptor unknown
011A	Security validation failed
011E	Incorrect object status



011F	Not enough memory space available.
0120	Node unknown.
0121	The channel object (CH) is in LOCK state
0122	Saturation - no plug available
0123	Object status = LOCK
0124	Connection block (TSCNX) already used
0125	Disconnection already running
0126	The connection block (TSCNX) is disconnected (or not connected)
0127	Change Credit value < 0
0128	Ineffective Change Credit ( delta = 0 )
0129	No more deferred letters
012B	"Reinitialization" Request
012C	"Reinitialization" in progress
012D	"Reinitialization" in progress, letters are dropped
012E	Close virtual circuit. Either no mapping exists between PA/NR or CL and VC/NS
012F	Null connection object index.
0130	Undefined function at Sysgen time.
0131	Letter too large with respect to the negotiated size.
0132	The received letter is longer than the size which was
0133	Disconnection of the session control user
0134	Interface error on EOR (End-Of-Record) processing.
013C	Presentation control protocol error.
013E	You do not have the turn.
013F	Message group closed.
0140	Session is closed.
0151	Request refused, no system buffers available.
0152	Incorrect addressing record.
0153	No presentation record in the ILCAL or ILCRL
0154	Negotiation failed on session mode
0156	Negotiation failed on resynchronization.
0157	Negotiation failed on END to END ACK
0158	No presentation record in the connection letter
0159	Negotiation failed on session mode
015A	Negotiation failed on letter size (in the Logical Connection record).
015B	Negotiation failed on resynchronization (in the Logical Connection record).
015C	Negotiation failed on end-to-end ACK (Logical Connection record).
015D	No support of the "letter" interface because Multirecord is not negotiated.
0160	Incorrect TSPACNX table.
0161	Protocol error on letter reception.

0162	Negotiation failure.
0163	Record header length error.
0164	Protocol error.
0165	Protocol error reception of control letter.
0166	Type or length error on interrupt letter.
0167	Protocol error on reception of data letter.
0168	Dialog protocol error.
0169	Unknown event.
016A	Protocol error on data transfer.
016B	Invalid status for a disconnection request.
016C	Invalid status for a recover
016D	Invalid status for a suspend/resume request.
016E	Negotiation failure.
016F	Unknown command.
0170	Error in presentation protocol
0171	Letter header length error in
0172	ILCAL is not DSA 200 protocol.
0173	Error in session record.
0174	Normal disconnection, without complementary reason code.
0175	Letter is not in ASCII or EBCD.
0176	Connection protocol letter header
0177	Letter header protocol error.
0178	Record header protocol error.
0179	Record header length error.
017A	Mbx record header length error.
017B	Error on buffer transfer.
017C	DSA 200 record header protocol
017D	DSA 300 record header protocol
017E	Unsupported connection options.
017F	Character error in ASCII string.
0180	No segmented record size.
0181	Invalid mailbox object index.
0182	Mapping error for a remote connection.
0190	No more buffers.
0191	Byte count is greater than GP.
0192	Byte count is greater than GP.
0193	Byte count is greater than GP.
0194	Byte count is greater than GP.
0195	Byte count is greater than GP.
0196	Byte count is greater than GP.
0197	Byte count is greater than GP.
0198	No more buffers.

0199	Byte count is greater than GP.
019A	Byte count is greater than GP.
019B	Byte count is greater than GP.
019C	Byte count is greater than GP.
019D	Byte count is greater than GP.
019E	Byte count is greater than GP.
019F	Byte count is greater than GP.
01A0	Invalid transfer state.
01A1	Suspend protocol running.
01A2	Suspend protocol running.
01A3	Recover protocol running.
01A4	Forbidden function in write request. (\$WRITE)
01A5	Conflicting parameters for segmented record. (SWBREC)
01A6	Protocol conflict - suspend/recover.
01A7	Protocol not supported - letter/end-to-end ACK. (SWBLET)
01A8	Multi-record letter in progress.
01A9	Interrupt request forbidden.
01AA	Send control record request forbidden. (SCTROL)
01AB	Forbidden for TWA session - turn is here. (SREAD)
01AC	Termination forbidden - suspend or recover in progress. (STERM)
01C0	No space available for downstream connection request. (SMECNX)
01C1	No space available for upstream connection request. (SMUCNX)
01C2	No space available for upstream SCF connection. (SMRCNX)
01C3	No space available for session context. (\$SCTX)
01E0	Enclosure or data length error for a write request. (\$WRITE)
01E1	Enclosure or data length error for a write segment record request. (SWBREC)
01E2	Enclosure error for 'give turn' request. (SGVTRN)
01E3	Interrupt request is not demand turn, attention/data attention, or purge record.
01E4	Input status for a send control letter is not permitted.
01E8	Write request without turn.
01E9	Write segmented record request without turn.
01EA	Write segmented letter request without turn.
01EB	Send control letter request without turn.
01EC	Disconnection request without turn.
<b>02xx</b>	<b>Presentation Control</b>
0201	Protocol level not supported
0202	Application designation protocol error.
0203	Character encoding error. TM cannot support the proposed encoding.
0204	Character set error. TM cannot support the proposed character set.

0205	Character subset error. TM cannot support the proposed character subset.
0206	Incorrect record encoding.
0207	Incorrect parameter encoding.
0230	Data presentation control error. The presentation control proposed for this session cannot be used
0231	Device type is incompatible with the configuration.
0232	TM control protocol is incorrect.
0233	Device-sharing attributes are invalid.
0234	Initiator or acceptor configuration is not correct.
0235	Logical device index error.
0236	Number of logical devices is incompatible with the configuration.
0237	TM protocol record not supported.
<b>03xx</b>	<b>Terminal Management</b>
0300	Sysgen error WARNING. There is no mapped object; some objects will be spare.
0301	Operator requested session abort or logged.
0302	Idle time run out after secondary network failure.
0303	Idle time run out for no traffic.
0304	Form not found.
0305	Operator requested suspension.
0306	Destructive attention send on the session.
0307	Unknown TX addressed in this session. TM is unable to a the session.
030A	Protocol error. A record was received which did not comply with current standards
0310	Insufficient resources. The receiver cannot act on the request because of a temporary
031E	Incorrect value for Retry or Wait parameters on UP LL command.
0320	Function not supported.
0321	Parameter error. This can result
0322	Resource not available. The
0323	Intervention required (on principal device).
0324	Request not executable.
0325	EOI required.
0326	Presentation space altered, request executed.
0327	Presentation space altered, request not executed.
0328	Presentation space integrity lost.
0329	Device busy. The device is busy and cannot execute the request.
032A	Device disconnected.
032B	Resource not configured.
032C	Symbol set not loaded.

032D	Read partition state error.
032E	Page overflow.
0330	Subsidiary device temporarily not available.
0331	Intervention required at subsidiary device.
0332	Request not executable because of subsidiary device.
0340	TM cannot accept a new connection.
0341	Object status incorrect.
0342	The TM configuration is not correct.
0343	Unknown TX addressed on this session.
0344	Data presentation protocol error.
0345	Device type is incompatible with the configuration, or is not supported.
0346	TM control protocol incorrect.
0347	Device shareability attributes are invalid.
0348	Initiator or acceptor configuration is not correct.
0349	Logical device index error.
034A	Number of logical devices incompatible with the configuration.
0350	Disconnection of TM after reinitialization of the network.
0360	File not found. (Welcome and Broadcast Messages)
0361	Site not found. (Welcome and Broadcast Messages)
0362	NASF error. (Welcome and Broadcast Messages)
0370	No-session timeout. Device disconnected.
0371	No-input timeout. Device disconnected.
0372	No-output timeout. Device disconnected.
0373	Timeout due to no backup session being initiated.
0374	Timeout due to no backup session being established.
0375	Connection refused because of late activation of back up session.
0376	Disconnection of current session to switch to backup session.
0380	AUTO CN parameter not declared.
0381	Mixed ETB in data sent by VIP screen and cassette
0382	Data header sent by the terminal incorrect.
0383	Desynchronization in the exchange of data.
0384	KDS block count error.
038C	Remote terminal is not connected
0390	Unknown mailbox.
0391	No call packet to return.
0392	No "Possibility" command to return Protocol error
03C0	Slave device disconnection.
<b>17xx</b>	<b>Network Layer</b>
1701	PAD connection refused.
1702	Flow control error.

1706	Logical channel number not zero in restart packet.
1707	Illegal packet length or use of D-bit forbidden.
1708	Illegal header.
1709	Illegal Logical Channel Number.
1710	Invalid packet type for the automaton state. Protocol error
1711	Incorrect packet type.
1712	Inconsistent network parameters in the generation file.
1713	No more space.
1714	DSAC network layer object not usable.
1717	USED/ENBL transition. Transport station is locked.
1718	USED/ENBL transition. This is a back-up NR.
1719	USED/ENBL transition. Dynamic close due to load.
171A	USED/ENBL transition. Transfer time-out has elapsed.
171B	USED/ENBL transition. This is a back-up NR.
171C	USED/ENBL transition. Transport station is idle.
171E	USED/ENBL transition. NR object is locked.
171F	ENBL/LOCK transition. NR HDLC has no more memory space.
1721	Remote station is inaccessible via the configured network. Check
1723	Incorrect PAD password.
1724	Virtual circuit already in use. LCN (Logical Channel Number) too high.
1725	Invalid virtual circuit.
1726	Packet too short. Protocol error for the equipment directly connected to the Bull Datanet.
1727	Incompatibility between the generation parameters of two communicating systems on window or packet size.
1729	Packet size in communicating systems not the same.
1731	Timer runs out while waiting for call confirmation.
1732	Timer runs out while waiting for clear confirmation.
1733	Timer has run out while waiting a reset confirm.
1740	Call setup or call clearing problem.
1741	Open failure on virtual circuit. No flow control on this NS.
1742	Incorrect facility. Protocol error for the equipment directly connected to the Bull Datanet.
1744	Unknown subscriber.
1745	End of time-out on reset confirm. Invalid facility length. Protocol error for the equipment directly
1747	No logical channel available.
1749	End of time-out on call confirm.
174F	Incorrect packet length. Protocol error for the equipment directly connected to the Bull Datanet.
1755	Flow control, window, packet size or reset error.

1760	Frame disconnection.
1770	Frame connection.
1771	Frame reset.
1781	No more network routes available for X.25 switching.
1782	Maximum of 15 switches have been used,
1783	Flow control negotiation error.
1785	Frame level disconnection.
1786	Frame level connection.
1787	Frame level reset.
1790	Frame level not established.
1791	No more logical paths available for the PAD.
1792	Echo service busy.
1793	Incorrect PAD password.
1794	All the PAD virtual circuits are used
1795	X.25 initialization not possible.
179B	LCN not null in restart packet
179D	Incompatible header (receive error: all VC of concerned NS
179E	LCN greater than NBVC in NS directive
179F	Incorrect packet type
17A0	Invalid facility.
17B0	Normal disconnection.
17B1	X.25 Echo in use.
17B2	No more logical channels available.
17B3	No more PAD connections allowed.
17B4	TS SX25 or NU X25 object locked.
17B5	Buffer capacity overflow.
17B6	Normal disconnection.
17B8	Unknown calling SNPA (Sub-Network Point of Attachment).
17B9	Internet problem.
17CB	Call collision on VC
17CC	Incompatible generations (NR object without mapping).
17CE	Invalid status NR locked.
17CF	Lack of space.
17D0	Unknown subscriber.
17D4	TSCNX already used for another connection. SCF internal error.
17D7	Transport station locked.
17DD	Proper NS locked.
17DE	Invalid status NR locked.
17DF	Lack of space.
17E0	Forbidden parameter or invalid value.
17E1	Invalid transition.
17E2	Upward-mapped object (TS) not locked.

17E3	No object mapped above.
17E4	NR not locked (MP NR -ADD/-SUB) or virtual circuit already open.
17E5	NR is last in list and the TS is not locked.
17E6	No object mapped above (UP NR -PRIO). NR not mapped on TS.
17E7	Upward mapped object not locked
17E9	Mix of datagram and connection network
17EB	Class inconsistent with NR.
17EE	Incompatible generations. NR object without mapping.
17FF	Wrong parameter in administrative CALL
<b>18xx</b>	<b>Transport Layer</b>
1800	Normal disconnection initiated by the correspondent
1801	Local saturation at connection request time.
1802	Failed negotiation at connection time.
1803	Duplicate connection. Two or more requests have been issued for the same connection.
1804	Redundant request.
1805	Retransmission Time-out at transport level.
1806	Survey time-out at transport level.
1807	Transport protocol error.
1808	Session Control specified is not available (inaccessible).
1809	Requested Session Control Id unknown by remote transport.
180A	Termination because of disconnection by administration.
180B	Session Control/Transport interface error.
180C	Connection request on non-sharable VC in case of ISO Transport. ISO: header or parameter length is invalid.
1817	Station in shut-down state.
181F	No memory space at connection time.
1821	Session Control inaccessible by configured session routes. ISO: Session entity not attached to TSAP.
1824	Collision between Close NC and Open TC.
182E	Remote station not configured.
182F	Resource saturation.
1831	ISO: No route for the called NSAP.
1832	ISO: Received NSAP addresses are wrong.
1833	Segmentation violation.
1834	ISO:QOS priority not available temporarily, due to a local condition (for example, lack of resources).
1835	ISO:QOS priority permanently unavailable locally (for example, due to an error in the system generation).
183A	ISO: Remote reason not specified.
183C	ISO: Remote transport entity congestion at connect request time.
1840	Server in terminating state. TC has been re-assigned on another NC.



18A1	An additional NC has been assigned to a TC.
18B0	NC has been re-assigned on another VC.
18EF	Disconnection at Transport level caused by reception of RESTART DSA during the transfer phase.

## Windows Sockets error Codes

Below is a list of Windows Sockets return codes and the corresponding description.

Hex code	Windows Sockets Access Error name	Description
2714	WSAEINTR	The (blocking) call was cancelled via WSACancelBlockingCall()
2719	WSAEBADF	The socket descriptor is not valid.
271E	WSAEFAULT	An invalid argument was supplied to the Windows Sockets API.
2726	WSAEINVAL	An invalid call was made to the Windows Sockets API.
2728	WSAEMFILE	No more file descriptors are available.
2733	WSAEWOULDBLOCK	The socket is marked as non-blocking and no connections are present to be accepted.
2734	WSAEINPROGRESS	A blocking Windows Sockets call is in progress.
2735	WSAEALREADY	The asynchronous routine being cancelled has already completed.
2736	WSAENOTSOCK	The descriptor is not a socket.
2737	WSAEDESTADDRREQ	A destination address is required.
2738	WSAEMSGSIZE	The datagram was too large to fit into the specified buffer and was truncated.
2739	WSAEPROTOTYPE	The specified protocol is the wrong type for this socket.
273A	WSAENOPROTOOPT	The option is unknown or unsupported.
273B	WSAEPROTONOSUPPORT	The specified protocol is not supported.

273C	WSAESOCKTNOSUPPORT	The specified socket type is not supported in this address family.
273D	WSAEOPNOTSUPP	The referenced socket is not a type that supports connection-oriented service.
273E	WSAEPFNOSUPPORT	
273F	WSAEAFNOSUPPORT	The specified address family is not supported by this protocol.
2740	WSAEADDRINUSE	The specified address is already in use.
2741	WSAEADDRNOTAVAIL	The specified address is not available from the local machine.
2742	WSAENETDOWN	The Windows Sockets implementation has detected that the network subsystem has failed.
2743	WSAENETUNREACH	The network address can't be reached from this host. There is probably a problem in the way you have set up TCP/IP routing for your PC (most likely you have not defined a default router).
2744	WSAENETRESET	The connection must be reset because the Windows Sockets implementation dropped it.
2745	WSAECONNABORTED	The connection has been closed.
2746	WSAECONNRESET	
2747	WSAENOBUFS	Not enough buffers available, or too many connections.
2748	WSAEISCONN	The socket is already connected.
2749	WSAENOTCONN	The socket is not connected.
274A	WSAESHUTDOWN	The socket has been shutdown.
274B	WSAETOOMANYREFS	
274C	WSAETIMEDOUT	Attempt to connect timed out without establishing a connection.
274D	WSAECONNREFUSED	The attempt to connect was forcefully rejected. The service on the other side is not available.
274E	WSAELOOP	Too many symbolic links were encountered in translating the path name.
274F	WSAENAMETOOLONG	
2750	WSAEHOSTDOWN	The host machine is out of service.
2751	WSAEHOSTUNREACH	The host machine is unreachable.

2752	WSAENOTEMPTY	
2753	WSAEPROCLIM	
2754	WSAEUSERS	
2755	WSAEDQUOT	
2756	WSAESTALE	
2757	WSAEREMOTE	
276B	WSASYSNOTREADY	Indicates that the underlying network subsystem is not ready for network communication.
276C	WSAVERNOTSUPPORTED	The version of Windows Sockets API support requested is not provided by this particular Windows Sockets implementation.
276D	WSANOTINITIALISED	A successful WSStartup() must occur before using this API.
2AF9	WSAHOST_NOT_FOUND	Authoritative answer host not found.
2AFA	WSATRY_AGAIN	Non-authoritative answer host not found, or SERVERFAIL.
2AFB	WSANO_RECOVERY	Non-recoverable errors, FORMERR, REFUSED, NOTIMP.
2AFC	WSANO_DATA	Valid name, no data record of requested type.